



# RED SWASTIKA SCHOOL

## SCIENCE 2022 END OF YEAR EXAMINATION PRIMARY 5

Name : \_\_\_\_\_ ( )

Class : Primary 5/ \_\_\_\_\_

Date : 1 November 2022

### BOOKLET A

Total time for Booklets A & B: 1h 45 min

Booklet A: 28 questions (58 marks)

**Note:**

1. Do not open the booklet until you are told to do so.
2. Read carefully the instructions given at the beginning of each part of the booklet.
3. Do not waste time. If the question is too difficult for you, go on to the next question.
4. Check your answers thoroughly and make sure you attempt every question.
5. In this booklet, you should have the following:
  - a. Page 1 to Page 21
  - b. Questions 1 to 28

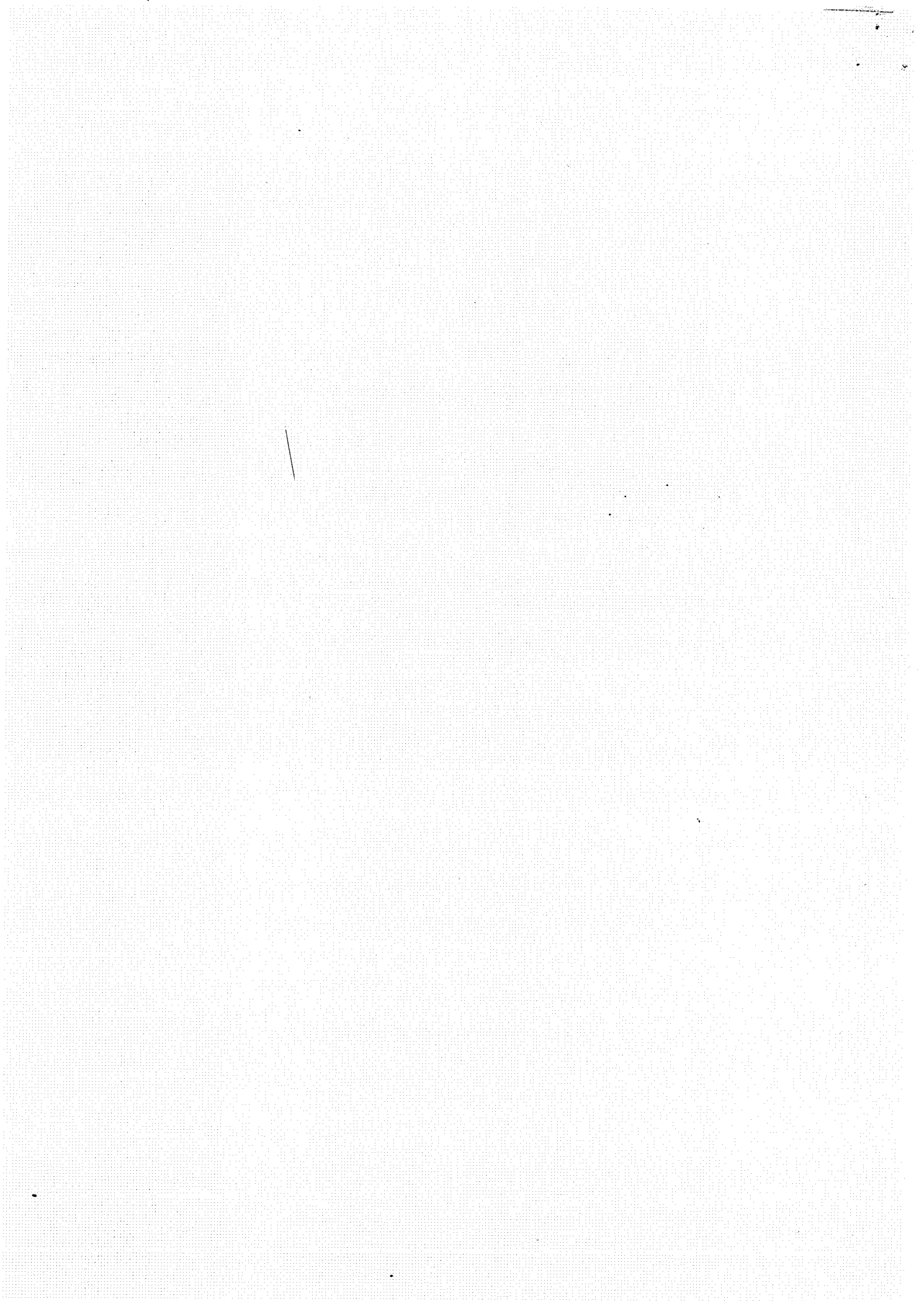

For Questions 1 to 28, choose the most suitable answer and shade its number in the OAS provided.

- 1 In the table below, A, B and C represent the characteristics of the given animals. A tick (✓) shows that the characteristic is present.

Animal	Characteristics		
	A	B	C
eagle	✓	✓	✓
snake		✓	
butterfly		✓	✓

Which of the following characteristics do A, B and C represent?

	A	B	C
(1)	Has scales	Can fly	Has legs
(2)	Has scales	Lays eggs	Can fly
(3)	Has feathers	Can fly	Has legs
(4)	Has feathers	Lays eggs	Can fly

- 2 Olivia found an animal in a stream deep in a forest.

Which of the following characteristics should she use to identify the animal as a/an amphibian, fish or reptile?

- (1) presence of gills
- (2) type of body covering
- (3) method of reproduction
- (4) whether it can live on both land and water

- 3 Kai He was choosing a material for part X of his running shoes, as shown in the diagram below.

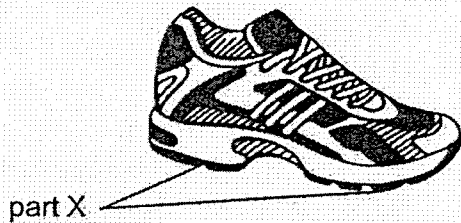

Which properties should he consider when choosing the material for part X?

- A: flexibility
- B: waterproof
- C: ability to allow light to pass through
- D: ability to float on water

- (1) A and B only
- (2) B and C only
- (3) A and D only
- (4) A, B and D only

- 4 Which of the following systems breaks down food into simple substances?

- (1) Skeletal system
- (2) Muscular system
- (3) Digestive system
- (4) Circulatory system

5 The diagram shows a plant cell.

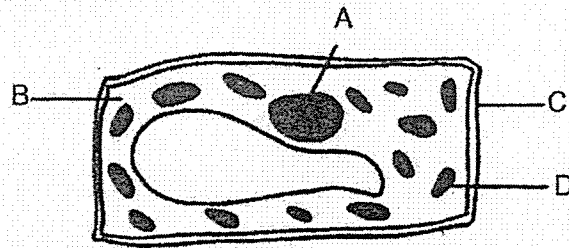

Which parts are not found in an animal cell?

- (1) A and B only
- (2) C and D only
- (3) B and D only
- (4) A and C only

6 The diagram below shows how blood is circulated in our body.

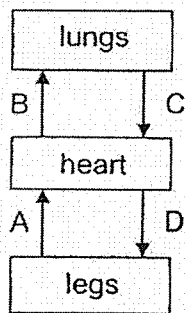

Which blood vessels transport blood rich in carbon dioxide?

- (1) A and B
- (2) A and C
- (3) B and C
- (4) C and D

- 7 Sanji removed the food-carrying tubes from the stem of a plant shown below. The water-carrying tubes remained in the stem.

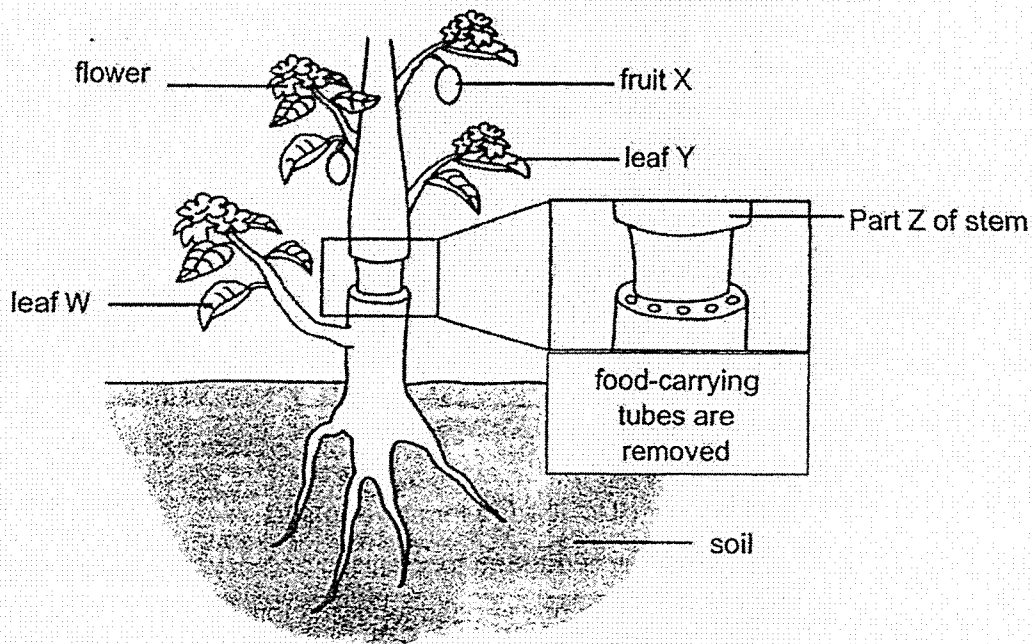

After some time, he observed some changes in the plant.

Which of the following is correct?

- (1) Leaf W died as no food was transported to it.
- (2) Leaf Y remained green as the leaf was still able to make food.
- (3) Fruit X became bigger than normal as more water was stored there.
- (4) Part Z of the stem was slightly swollen as water could not be transported from the stem to the roots.

- 8 Zoro conducted an experiment as shown below. Both set-ups A and B contained the same volume of water and were placed next to a window.

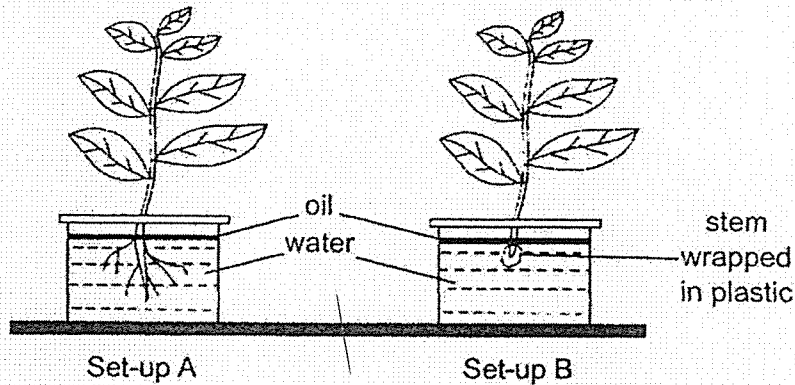

At the end of three days, Zoro observed that more water was left in set-up B.

What is the aim of the experiment?

- (1) To find out if oil is needed for plants to survive.
  - (2) To find out if air is needed for plants to photosynthesise.
  - (3) To find out if roots are needed for plants to absorb water.
  - (4) To find out if presence of light affects the growth of plants.
- 9 Which of the following diagrams correctly represents the life cycle of a butterfly?

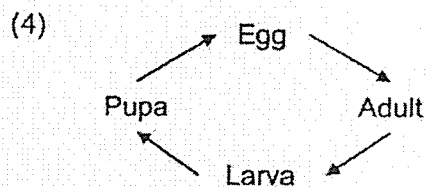
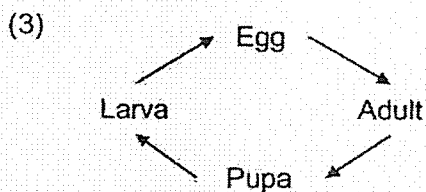
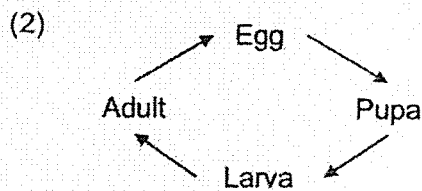
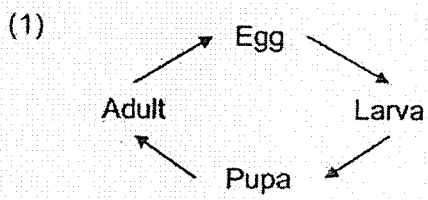

10 Study the plant and human reproductive systems as shown below.

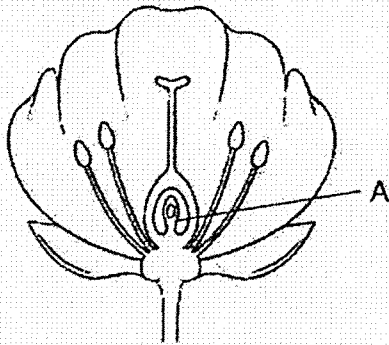

plant reproductive system

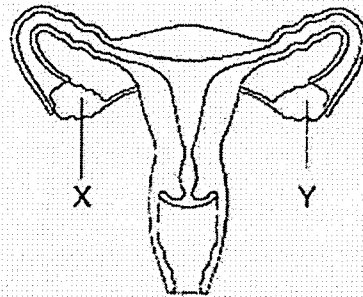

human reproductive system

Which one of the following statements is true?

- (1) If part X is removed, fertilisation will not be able to occur.
- (2) If part A is removed, fertilisation will not be able to occur.
- (3) Only parts X and Y produce female reproductive cells in both systems.
- (4) Parts A, X and Y produce the male reproductive cells in both systems.



\*11 The diagram below shows four different stages of growth of a bean plant.

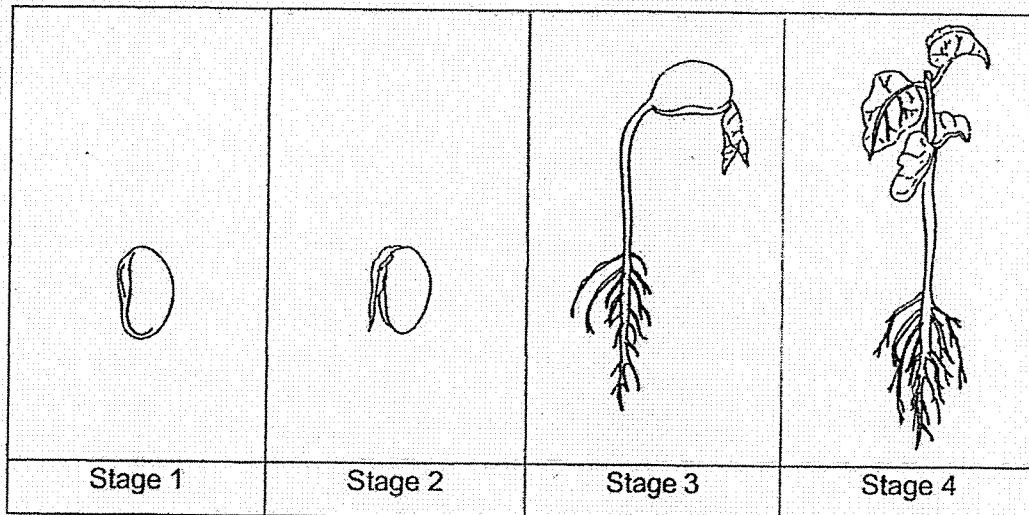

The graph shows the change in mass of a seed leaf as the plant grows.

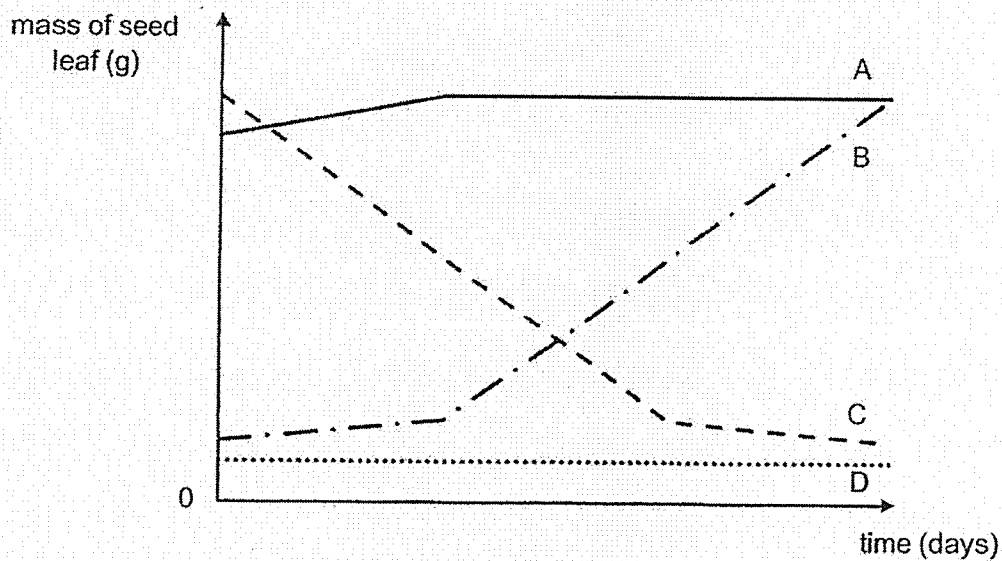

Which of the following graphs, A, B, C and D, correctly shows the change in mass of the seed leaf as the plant grows from stage 1 to 4?

- (1) A
- (2) B
- (3) C
- (4) D

12 Study the diagram below.

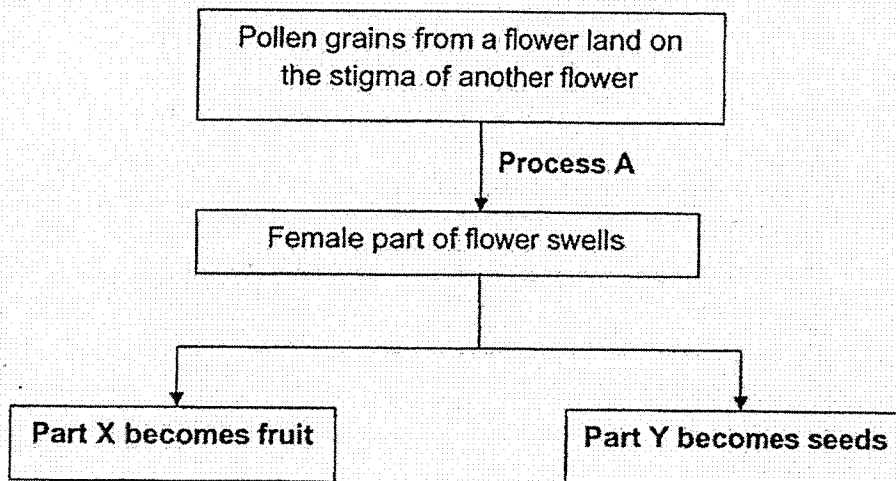

Which of the following correctly represents process A, part X and part Y?

	Process A	Part X	Part Y
(1)	Germination	Ovary	Ovules
(2)	Fertilisation	Ovary	Ovules
(3)	Germination	Ovules	Ovary
(4)	Fertilisation	Ovules	Ovary

13 The picture below shows an electrical plug with parts labelled A and B.

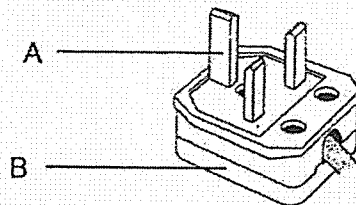

an electrical plug

Which of the following correctly represents the parts labelled A and B?

	A	B
(1)	conductor of electricity	insulator of electricity
(2)	insulator of electricity	insulator of electricity
(3)	conductor of electricity	conductor of electricity
(4)	insulator of electricity	conductor of electricity

14 Identical batteries and bulbs are used to set up the four circuits as shown below.

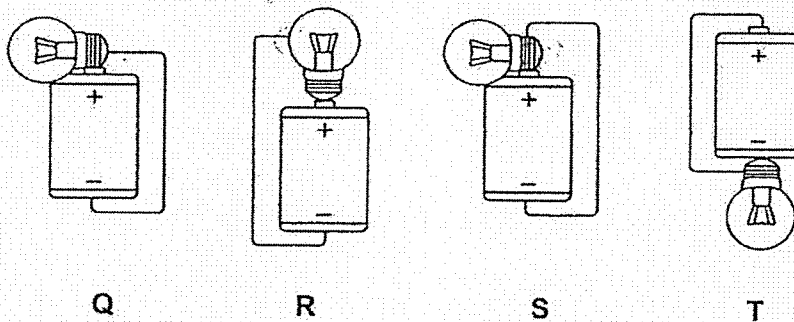

In which of the two electrical circuits will the bulb light up?

- (1) Q and R
- (2) R and S
- (3) Q and T
- (4) S and T

- 15 Siti set up four circuits, A, B, C and D, as shown below. She wanted to find out if the arrangement of bulbs in a circuit affects the brightness of the bulb(s).

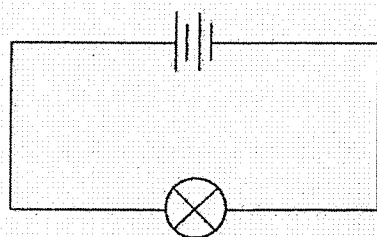

circuit A

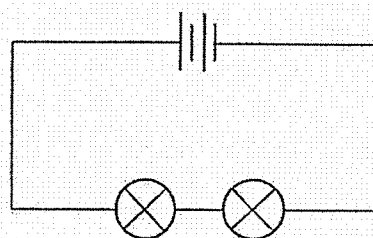

circuit B

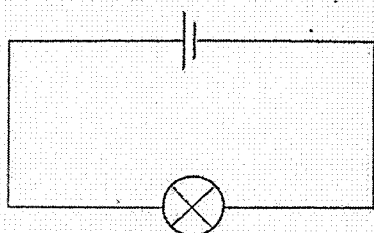

circuit C

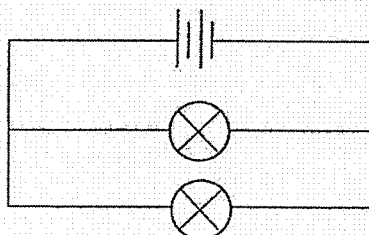

circuit D

Which two circuits should she use for her investigation?

- (1) A and C
- (2) B and D
- (3) B and C
- (4) C and D

- 16 Peter constructed an electrical circuit as shown below. He used two identical batteries, three identical switches and four objects, E, F, G and H. One of the objects used was a light bulb.

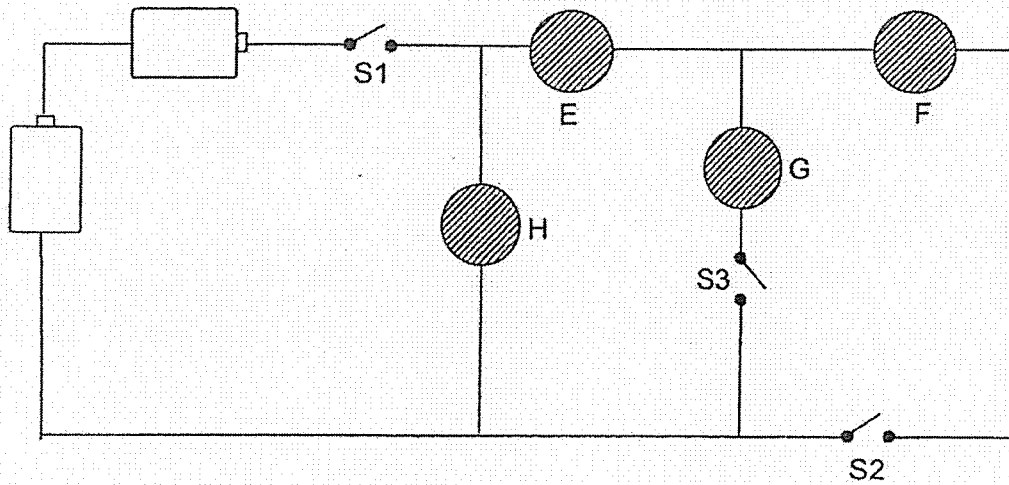

Peter made the following observations when he closed some switches.

Switches that are closed	Observations
S1 and S3	bulb lighted up
S1 and S2	bulb did not light up

Which object is the light bulb?

- (1) E
- (2) F
- (3) G
- (4) H

17 The flowchart below is used to classify three types of matter, A, B and C.

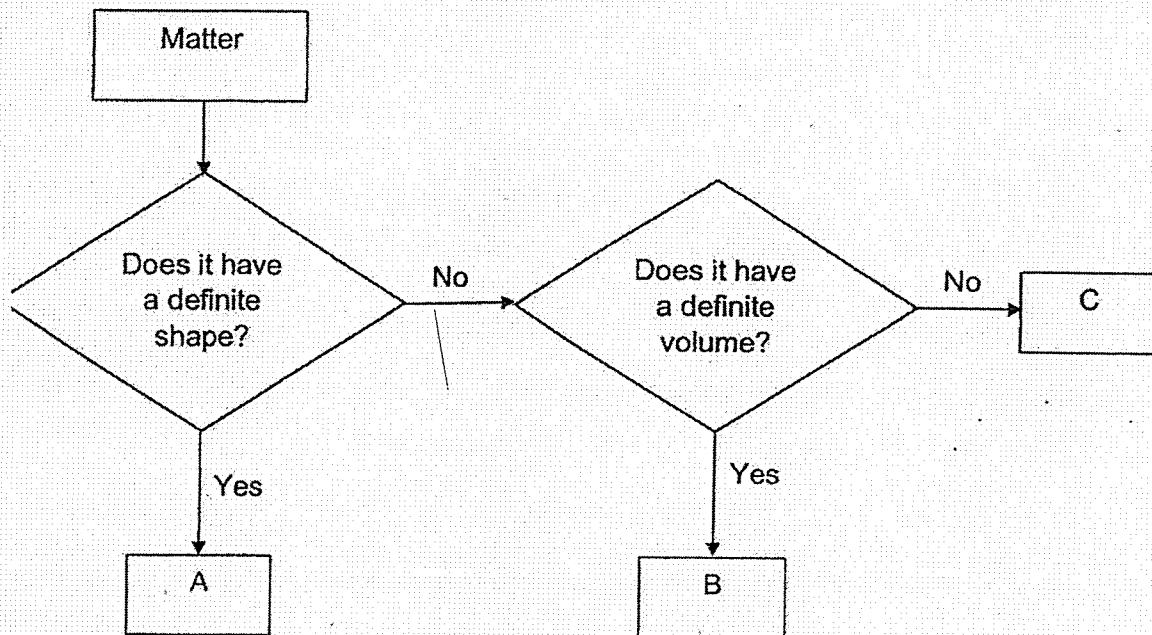

Which of the following correctly represents matter, A, B and C?

	A	B	C
(1)	oil	book	ice
(2)	ice	oil	air
(3)	ice	oil	book
(4)	oil	book	air

- 18 Sally poured the same amount of water into two cups, A and B, and placed a metal lid over each cup. The cups were left on a kitchen table. After half an hour, she observed the following as shown in the diagrams below.

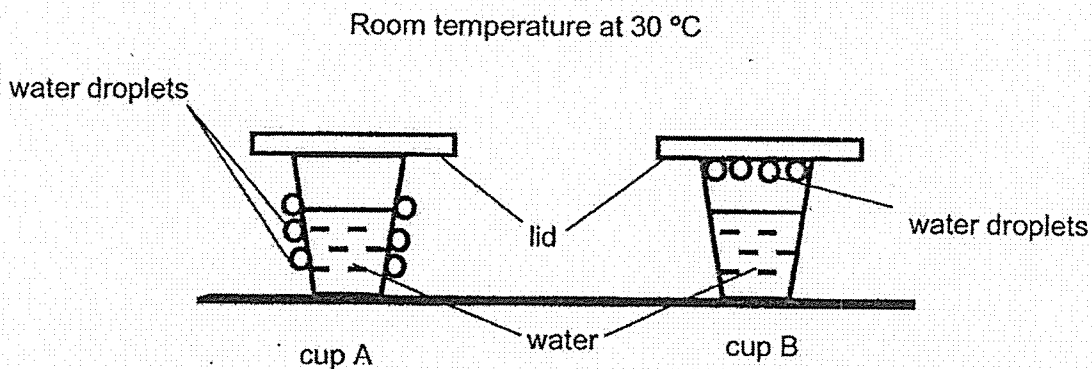

Which of the following shows the most possible temperature of the water in cups A and B?

Temperature of water (°C)	
cup A	cup B
(1) 80	10
(2) 80	80
(3) 10	80
(4) 10	10

- 19 Tommy filled a measuring cylinder with  $100 \text{ cm}^3$  of water. He placed three objects, X, Y and Z into it, as shown in Diagram A. He removed the objects one by one. He measured and recorded the volume of water in the cylinder after each object was removed as shown in Diagrams B and C below.

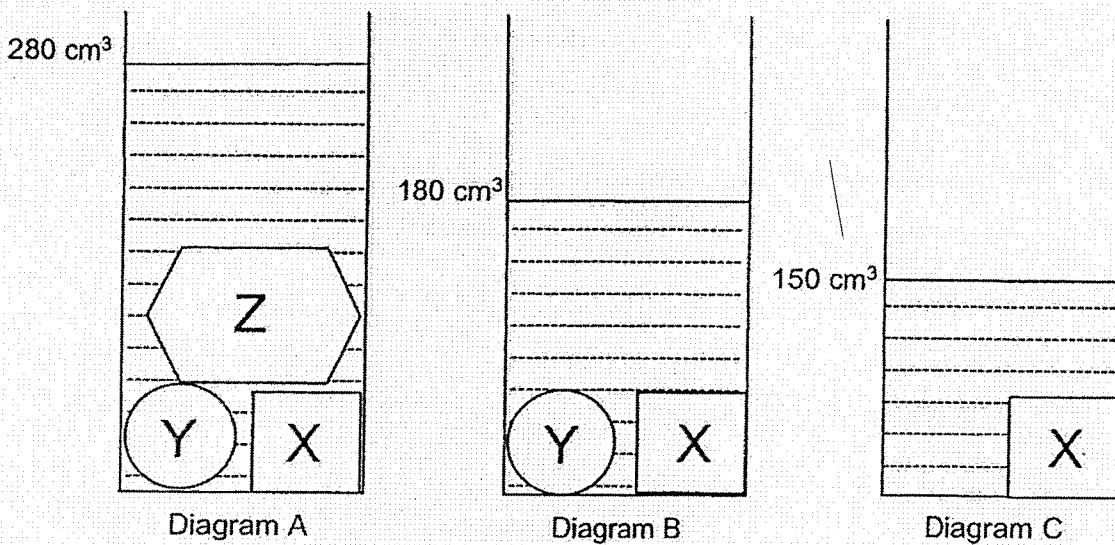

Based on the diagrams, which of the following statement(s) is/are true about X, Y and Z?

- A: Object Z occupied most amount of space.
- B: Object X occupied less space than object Y.
- C: Objects Z and Y each occupied the same amount of space.

- (1) A only
- (2) B only
- (3) A and C only
- (4) B and C only



20 Study the diagram of the water cycle below.

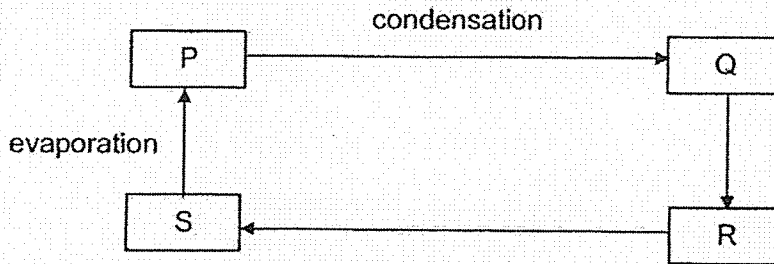

What do the letters, P, Q, R and S, represent?

	P	Q	R	S
(1)	rain	water bodies	clouds	water vapour
(2)	water bodies	water vapour	clouds	rain
(3)	clouds	rain	water bodies	water vapour
(4)	water vapour	clouds	rain	water bodies

21 Ariel has two cups, A and B made of material P. She poured an equal amount of hot water into each cup. Ariel noticed that it was too hot for her to hold cup A but she could hold cup B easily as shown below.

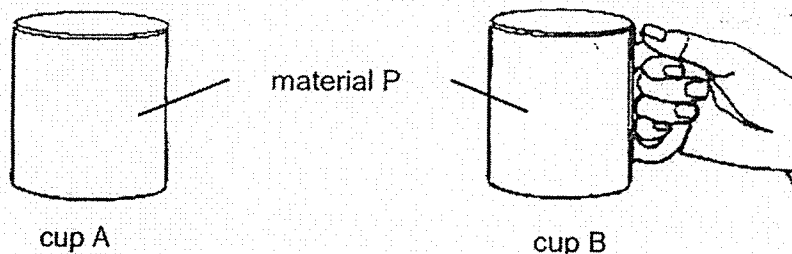

Which of the following best explains why Ariel can hold cup B easily but not cup A?

- (1) Cup B is a poor conductor of heat.
- (2) Cup A is a good conductor of heat.
- (3) Distance of heat source to her hand is greater in cup A.
- (4) Distance of heat source to her hand is greater in cup B.

- 22 Harun conducted an experiment in a dark room. He lighted up two bulbs and the shadows were formed as shown in the diagram below.

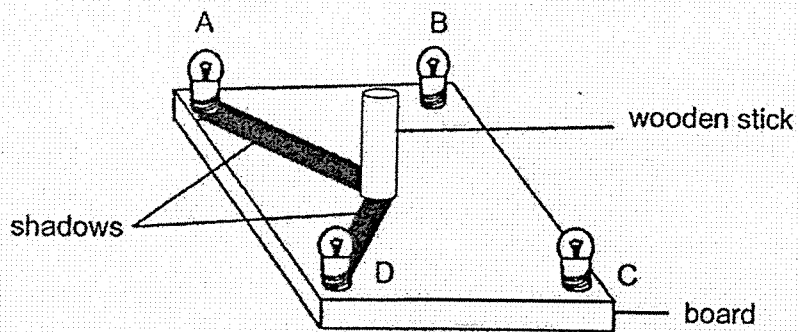

Which two bulbs, A, B, C or D, should Harun light up to cast the shadows as shown above?

- (1) A and B
- (2) C and D
- (3) A and D
- (4) B and C

- 23 A container of water was left in a room for 30 minutes. The temperature of the water was recorded every 10 minutes as shown in the graph below.

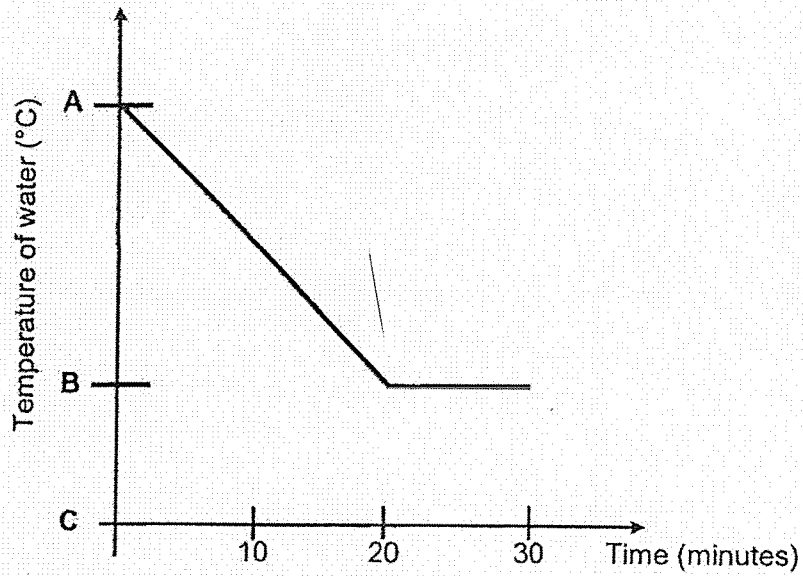

Based on the graph, which of the following statements is correct?

- (1) A is the temperature of the room.
- (2) B is the temperature of the room.
- (3) C is the temperature of the room.
- (4) C is the temperature of the water.

- 24 A compass has a small magnet that can rotate freely as shown. Two compasses were placed near both ends of a magnet.

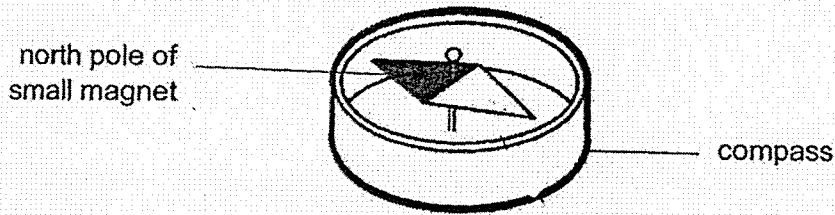

Which diagram show the directions of the needles in the compasses?

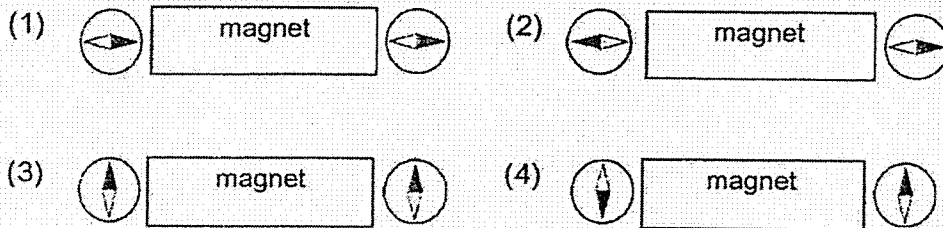

- 25 Farhana put four identical magnets side by side as shown below.

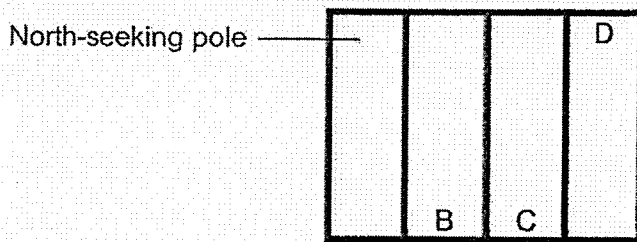

Which of the following correctly represents the poles at B, C and D?

	B	C	D
(1)	South-seeking pole	North-seeking pole	North-seeking pole
(2)	North-seeking pole	North-seeking pole	North-seeking pole
(3)	North-seeking pole	South-seeking pole	South-seeking pole
(4)	South-seeking pole	South-seeking pole	South-seeking pole

- 26 An object is attached to a spring as shown below. Forces, A and B are acting on the object as shown below.

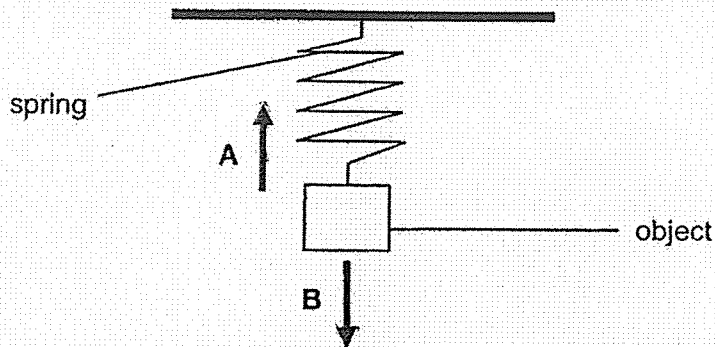

Which of the following correctly represents the types of forces A and B?

	A	B
(1)	magnetic force	gravitational force
(2)	elastic spring force	gravitational force
(3)	gravitational force	frictional force
(4)	frictional force	magnetic force

- 27 The diagram below shows a magnetic photo stand where the photo frame was suspended in the air between parts A and B.

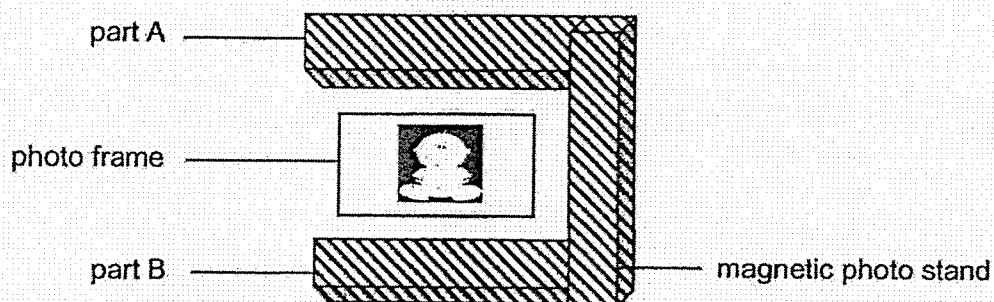

Which of the following statements explain why the photo frame could be suspended in the air between parts A and B?

- A There was magnetic force acting on the frame.
- B There was elastic spring force acting on the frame.
- C There was no gravitational force acting on the frame.
- D The magnetic force acting on the frame was greater than the gravitational force acting on it.

- (1) A and C only
- (2) C and D only
- (3) B and C only
- (4) A and D only

28 Coen wanted to use a slingshot to hit the cans as shown below.

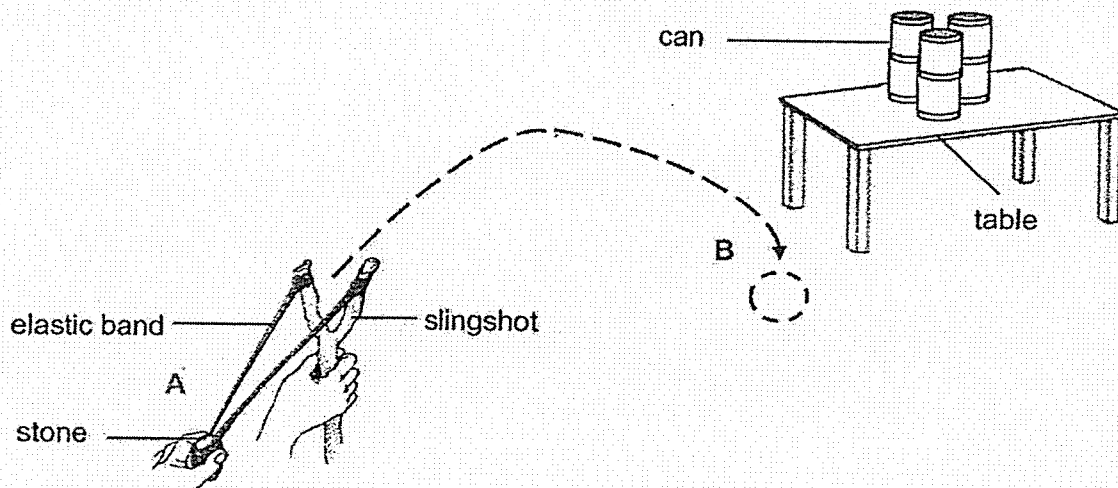

When Coen pulled back the elastic band and then released the stone at point A, the stone moved along the dotted line as shown above. The stone dropped on the ground at point B.

Which of the following is/are possible explanations for the observation?

- A: The elastic band was not stretched long enough.
- B: Gravitational force pulled the stone down to the ground.
- C: Frictional force between the stone and elastic band pulled the stone down.

- (1) A only
- (2) B and C only
- (3) A and B only
- (4) A, B and C

End of Booklet A



# RED SWASTIKA SCHOOL

## SCIENCE 2022 END OF YEAR EXAMINATION PRIMARY 5

Name : \_\_\_\_\_ ( )

Class : Primary 5/ \_\_\_\_\_

Date : 1 November 2022

### BOOKLET B

12 Questions  
44 Marks

In this booklet, you should have the following:

- Page 22 to Page 34
- Questions 29 to 40

### MARKS

	OBTAINED	POSSIBLE
BOOKLET A		56
BOOKLET B		44
TOTAL		100

Parent's Signature : \_\_\_\_\_



Answer all the questions in the spaces provided.

29 The diagram below shows a grasshopper.

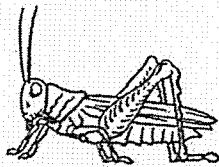

grasshopper

(a) Which group of animals should grasshoppers belong to? Explain your answer. (2m)

---

---

George conducted an experiment to find out if the presence of water affects the survival of grasshoppers.

(bi) Put a tick (✓) beside the variable(s) that George kept the same for a fair test. (1m).

	Variable	To be kept the same
(i)	Presence of water	
(ii)	Location of tanks placed	
(iii)	Number of grasshoppers in each tank	
(iv)	Number of days that the grasshoppers are kept in the tank	

(bii) Explain why the variable(s) in (bi) should be kept the same. (1m)

---

---

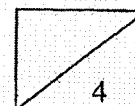

30 Study the classification chart below.

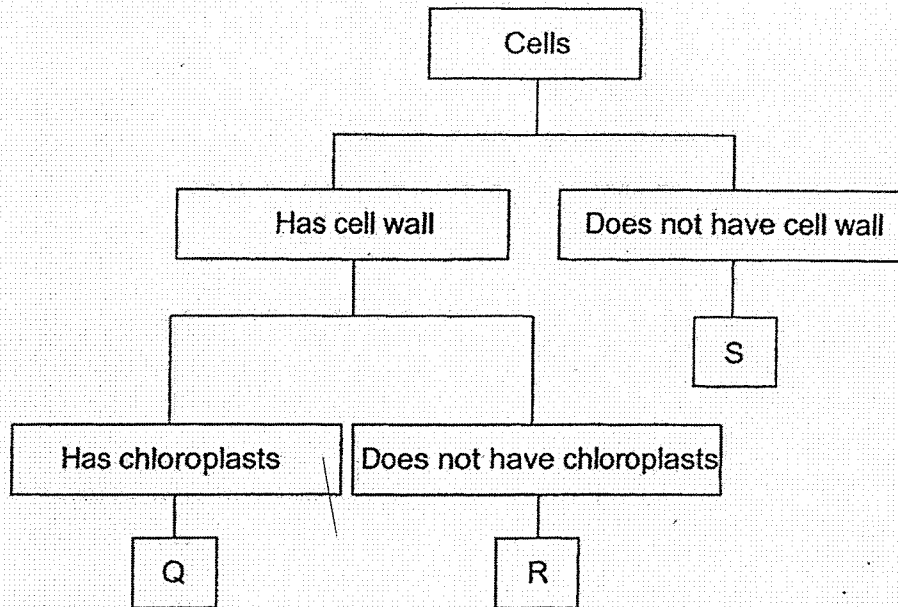

(a) Based on the chart above, which cell, Q, R or S, is most likely a root cell? Explain why. (2m)

---



---

Bala found a single-celled organism that lives in freshwater ponds as shown below.

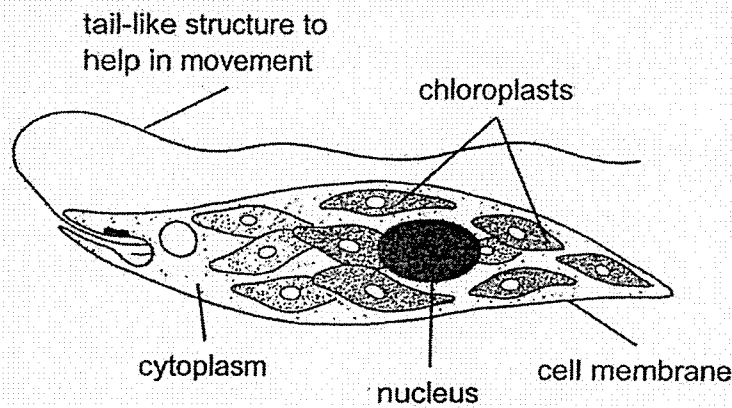

(b) Based on the diagram, explain how the organism can make its own food. (1m)

---



---

31 A headache can be felt by an individual when there is less oxygen being transported to the brain.

While having a headache, Jake realised that his heartbeat was faster.

(a) Explain why the heart pumps faster when Jake gets a headache. (2m)

---



---



---

(b) Other than the substance mentioned in part (a), what is another substance transported by the blood? (1m)

---

32 The diagram below shows how substances are transported in a plant. P and Q represent different parts of the plant. The arrows represent the movement of substances G and H.

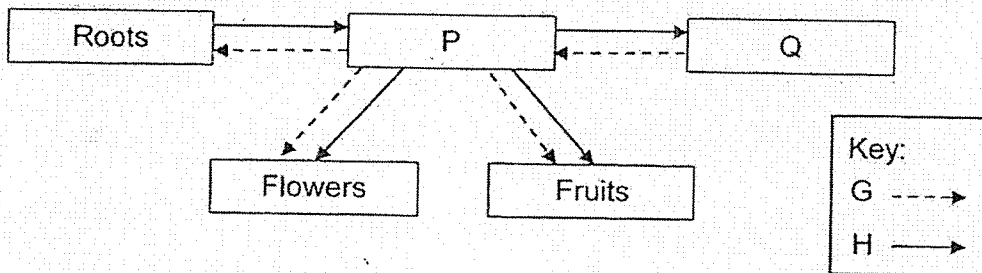

(a) Identify substances G and H. (1m)

G \_\_\_\_\_

H \_\_\_\_\_

(b) Identify part P and describe its role in the plant. (2m)

---



---



---

33 Bees are often found near flower N.

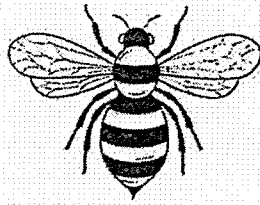

bee

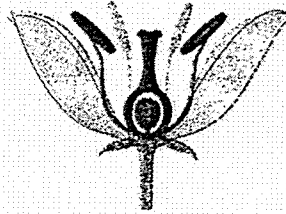

flower N

(a) Describe how bees help plants reproduce. (1m)

---

---

The graphs below show the average temperature of a country over 20 years and the effect of temperature on the number of bees.

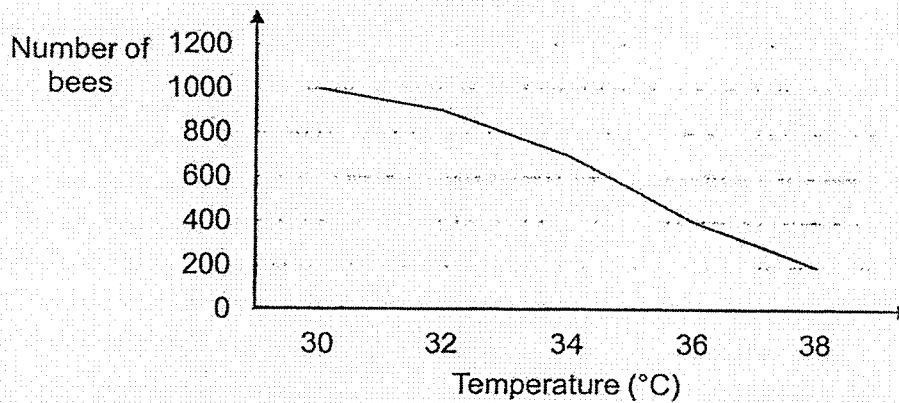
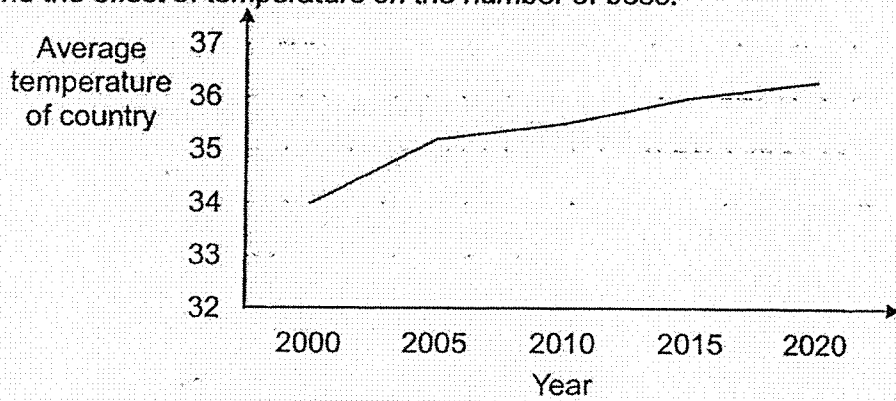

(bi) What is the relationship between the temperature of the country and the number of bees? (1m)

---

---

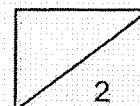

(bii) Based on the information above, what would happen to the population of plant N from year 2000 to 2020. Explain why. (2m)

---

---

---

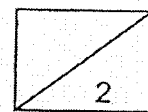

34 Dengue is a disease caused by the dengue virus which is transmitted to humans through the bite of an *Aedes* mosquito.

(ai) Name the correct stages in the life cycle of a mosquito in the blanks below. (1m)

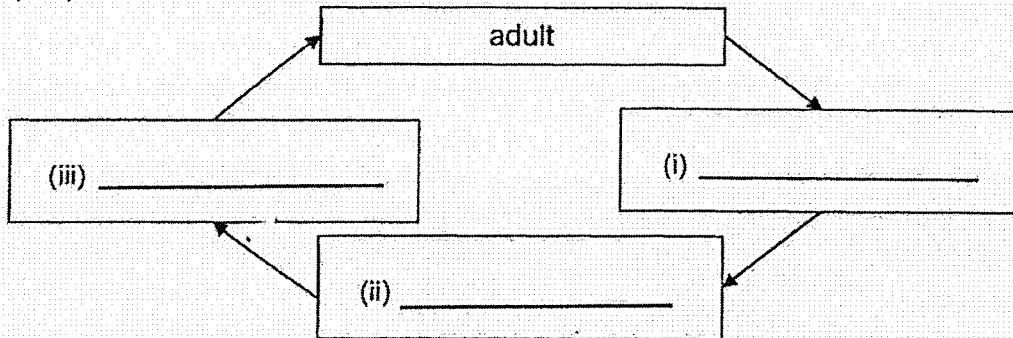

(aii) At which stage of its life cycle does the mosquito not live in water? (1m)

\_\_\_\_\_

(b) In some houses, pole holders are fixed outside the kitchen windows. These are used to hold bamboo poles where wet clothes are hung on them to dry. The bamboo poles were then inserted into the pole holders.

The diagrams below show examples of an uncovered and a covered bamboo pole holders found outside the kitchen windows of Lilin's house and Brook's house.

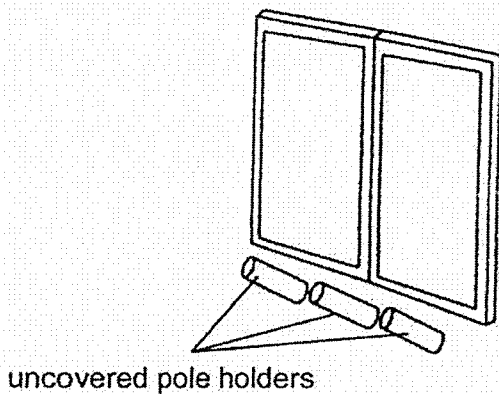

uncovered pole holders

Lilin's house

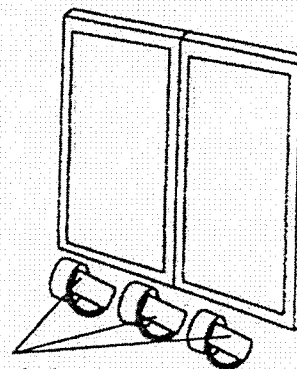

covered pole holders

Brook's house

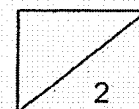

- (i) Lilin found more mosquitoes in her house than in Brook's house. Explain why. (2m)

---

---

---

To reduce the number of mosquitoes in the country, Country S has designed a trap to attract and capture female adult mosquitoes that are looking for places to lay their eggs. Once they enter this trap, the adult female mosquitoes will not be able to escape.

- (ii) Suggest why this trap reduces the number of mosquitoes in Country S. (1m)

---

---

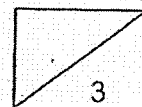

- 35 Eric set up an electrical circuit as shown in Diagram 1 below. All the circuit components are working.

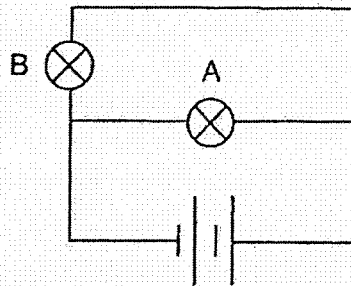

Diagram 1

- (a) Name the type of arrangement of bulbs A and B in diagram 1. (1m)

---

- (b) If bulb B fuses, will bulb A continue to light up? Explain why. (2m)

---

Next, Eric added bulbs C and D in the circuit as shown in diagram 2 below. All four bulbs are identical and in working condition.

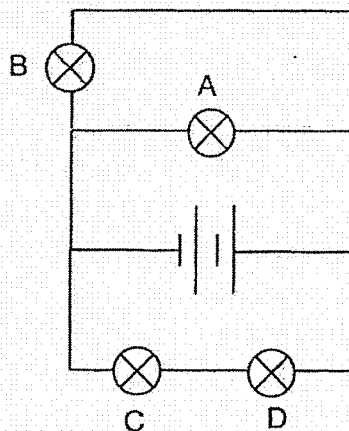
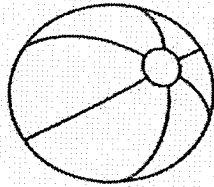

Diagram 2

- (c) Two switches are added to the circuit. When these two switches are open, only bulb B lights up. In the circuit diagram above, draw the positions of the two switches with a letter 'X'. (2m)



36 Wei Xuan pumped air into a beach ball as shown below.



Wei Xuan found that she can continue to pump air into the beach ball even when it is fully inflated.

(a) What physical property of air allowed her to do this? (1m)

---

(b) Did the mass of the beach ball increase, decrease or remain the same after she pumped more air into it? Give a reason for your answer. (1m)

---

---

Wei Xuan observed that the beach ball became firmer after the ball was left under the hot sun for some time.

(c) Explain why the beach ball became firmer after some time. (1m)

---

---

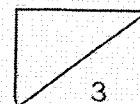

- 37 Andy wanted to dry his hands after washing them. He placed his hands under the hand-dryer to dry them.

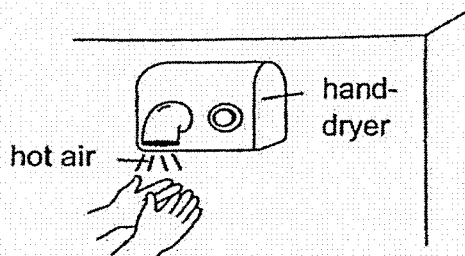

- (a) Andy's hands were dry after a few minutes. Explain how his wet hands became dry after a while. (1m)

---

---

Andy wanted to find out if the temperature of air will affect the time taken to dry a pair of wet hands. He conducted an experiment and recorded the results in the table below.

Temperature of air from hand-dryer ( $^{\circ}\text{C}$ )	Time taken for hands to be completely dry (seconds)
30	60
35	45
40	30

- (bi) Based on his results above, state how the temperature of air affects the time taken for the hands to dry completely. (1m)

---

---

- (bii) When Andy increased the wind speed of the hand-dryer, would the time taken for his hands to dry completely increase, decrease or remain the same? Explain your answer. (1m)

---

---

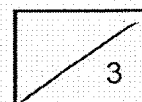

- 38 The diagram below shows the shapes of the shadows produced when two different objects were placed between a screen and a torch. The size of the objects is given in the box on the right.

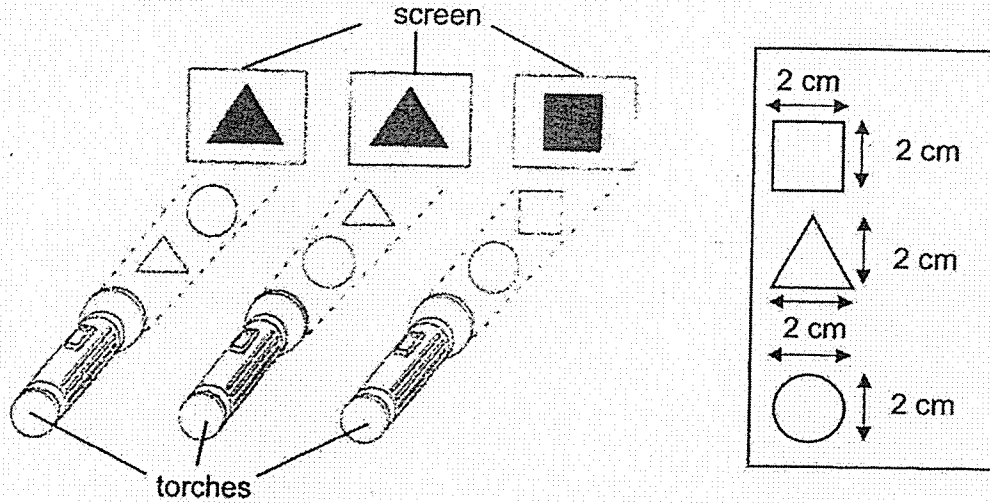

A hole was made in the centre of the square object and it was then placed in front of the screen together with the triangular object, as shown below.

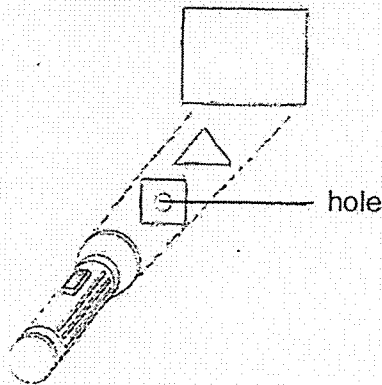

- (a) Tick (✓) the correct shadow which will be formed on the screen. (1m)



- (b) Explain your choice in (a). (2m)

---



---

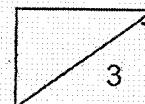

- 39 Bobby wanted to use a metal knife to cut a frozen ice cream cake but he found it difficult to do so. He then placed the knife in a glass of hot water as shown below.

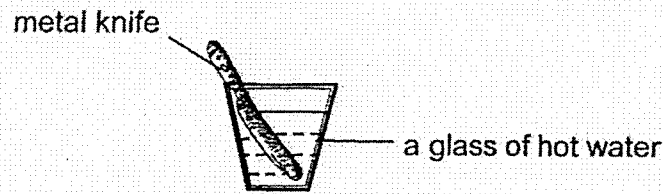

- (a) Explain why Bobby found it easier to cut the ice cream cake by using the knife placed in hot water. (1m)

---

---

- (b) After some time, Bobby had to put the knife back into the hot water before cutting another piece of cake after some time. Explain why. (2m)

---

---

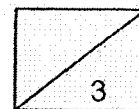

- 40 Jiamin released a block from the top of a plank. The block moved down the plank.

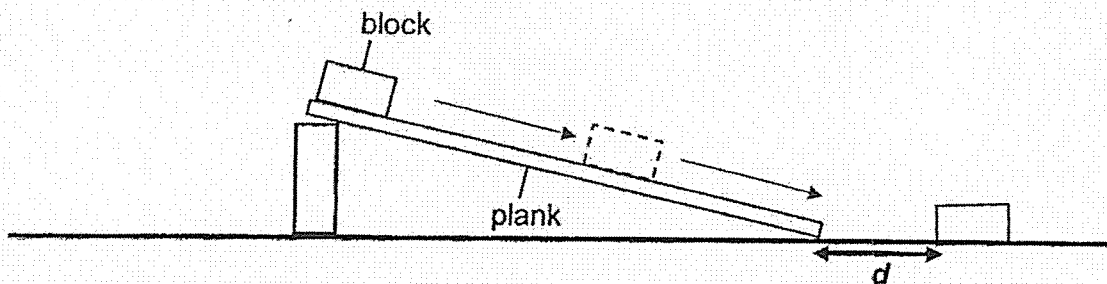

- (a) Name two forces acting on the moving block. (2m)

---

---

She repeated her investigation by adding two wheels below the block as shown below.

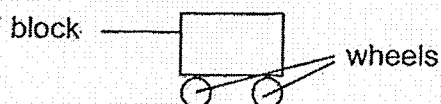

- (b) She noticed that the distance,  $d$ , moved by the block was longer. Why is that so? (1m)

---

---

- (c) Other than adding the wheels to the block, suggest two other ways Jiamin can do to make the block travel a longer distance. (2m)

---

---

**End of Booklet B**  
**Please check your work.**

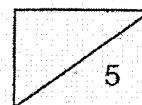

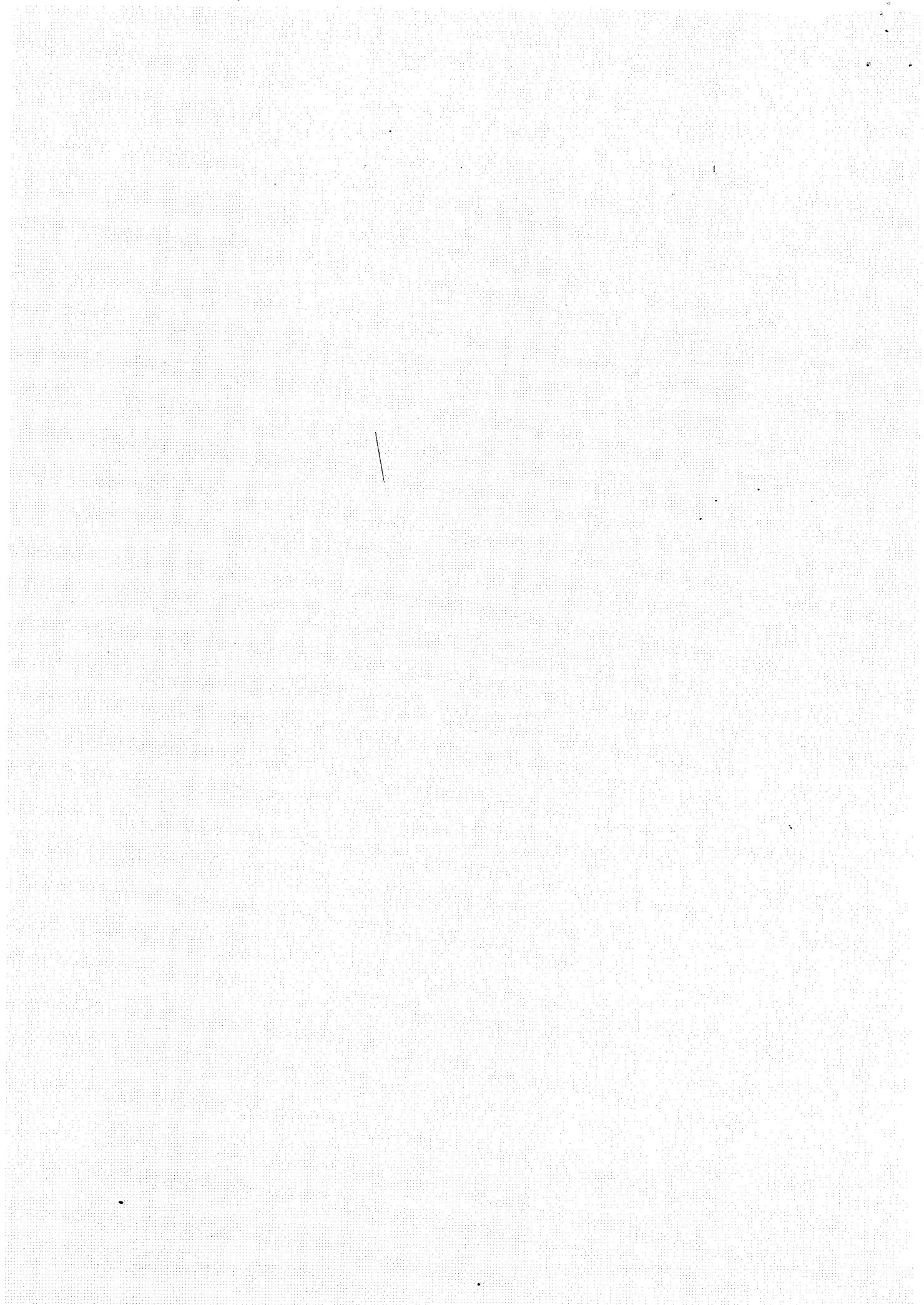

Corrections for P5 Science End of Year Examinations

Name: \_\_\_\_\_ ( ) Class: P5/ \_\_\_\_\_ Date: \_\_\_\_\_

1	(4)	6	(1)	11	(3)	16	(3)	21	(4)	26	(2)
2	(2)	7	(2)	12	(2)	17	(2)	22	(4)	27	(4)
3	(1)	8	(3)	13	(1)	18	(3)	23	(2)	28	(3)
4	(3)	9	(1)	14	(3)	19	(1)	24	(1)		
5	(2)	10	(2)	15	(2)	20	(4)	25	(3)		

29a	Insect. Grasshoppers have <u>3</u> body parts / have <u>3</u> pairs of legs.		
bi	Variable		Constant
	(i)	Presence of water	
	(ii)	Location of tanks placed	✓
	(iii)	Number of grasshoppers in each tank	✓
	(iv)	Number of day that the grasshoppers in the tanks	✓
bii	The survival of the grasshopper is due to one changed variable, <u>the presence of water</u> .		
30a	<u>R</u> . Cell R has a <u>cell wall</u> and <u>no chloroplast</u> . A root cell is a <u>plant cell</u> and <u>does not make its own food</u> .		
b	The organism has chloroplasts which contain <u>chlorophyll</u> to trap light which allows the organism to make its own food.		
31a	The heart pumps <u>faster</u> so that the blood can <u>transport more</u> oxygen to the <u>brain/head</u> .		
b	<u>Digested food/ carbon dioxide/ waste products</u>		
32a	<u>G: food/ sugar/ starch</u>		<u>H: water</u>
b	P is the <u>stem</u> and it contains <u>water-carrying tubes</u> and <u>Food -carrying tubes</u> . <u>Water-carrying tubes transport water from the roots to all parts of plant</u> while the <u>food-carrying tubes transport food from the leaves to all parts of plant</u> .		
33a	The bees helps to <u>transfer pollen grains</u> from the <u>anther</u> to the <u>stigma</u> of a flower.		
bi	As the temperature of the country <u>increases</u> , the number of bees <u>decreases</u> .		
bii	The population of plant N will decrease. From 2000 to 2020, the <u>temperature</u> of the country <u>increases</u> so there are <u>less adult bees to pollinate</u> the flowers. With less pollination, <u>less fertilisation / less flowers will develop into fruits</u> will take place. Thus, resulting in less seeds dispersed and <u>less seeds of plant N to germinate</u> .		
34a	(i) Egg	(ii) Larva	(iii)Pupa      aii Adult stage
bi	The uncovered bamboo pole holders allow <u>water</u> to be collected after rain. Adult mosquitoes will then be able to <u>lay eggs</u> which will <u>hatch into larvae / young</u> .		
bii	The trap will cause the number of female mosquitoes to decrease in the country. Thus, there will be <u>less</u> eggs laid which will <u>develop into less</u> young.		



35a	<u>Parallel</u> arrangement
35b	If bulb B fuses, bulb A will still <u>light up</u> . Electricity will be able to flow through bulb A in a <u>closed circuit</u> because bulbs A and B are arranged in <u>parallel</u> .
35c	
36a	Air has <u>no definite volume</u> .
36b	The mass <u>increased</u> as air has <u>mass</u> .
36c	Air in the beach ball <u>gain heat</u> from the sun and <u>expanded</u> .
37a	<u>Water</u> on Andy's hands <u>gained heat</u> from the hot air /hand-dryer and <u>evaporated into water vapour</u> .
37bi	As the temperature of air <u>increases</u> , the time taken to dry the hands completely <u>decreases</u> .
37bii	The time taken will <u>decrease</u> . As the wind speed increases, the <u>rate of evaporation</u> of the water droplets <u>increase</u> .
38a	■ (✓)
38b	Both the <u>triangle and square do not allow light to pass through</u> . The square is <u>closer</u> to the torch and <u>blocks more light</u> .
39a	The knife in cup Q <u>gains heat</u> from the hot water which melts the frozen ice cream <u>cake</u> at a faster rate/shorter time.
39b	The knife <u>lost heat</u> to the ice cream/surroundings after some time. He put the knife back to allow it to <u>gain heat</u> from the hot water.
40a	1. <u>Gravity/ Gravitational force</u> 2. <u>Friction/ Frictional force</u>
40b	The wheels <u>reduce the frictional force between</u> the block <u>and the plank</u> .
40c	<ul style="list-style-type: none"> <li>• release the block with a greater push/force</li> <li>• add lubricant/water/oil</li> </ul>