

--	--	--	--	--	--	--



SINGAPORE CHINESE GIRLS' SCHOOL
PRELIMINARY EXAMINATION 2022

PRIMARY 6
MATHEMATICS
PAPER 1
(BOOKLET A)

Total Time for Booklets A and B: 1 h

Name : _____ ()

19 August 2022

Class : Primary 6 SY

Mathematics Teachers

SL / CTEO / LXJ / KYS /

INSTRUCTIONS TO CANDIDATES

1. Write your Index No. in the boxes at the top right hand corner
2. Do not turn over this page until you are told to do so.
3. Follow all instructions carefully.
4. Answer all questions.
5. Shade your answers in the in the Optical Answer Sheet (OAS) provided
6. The use of calculators is **NOT** allowed.

This booklet consists of **6** printed pages and **1** blank page.

Booklet A

Questions 1 to 10 carry 1 mark each. Questions 11 to 15 carry 2 marks each.
For each question, four options are given. One of them is the correct answer.
Make your choice (1, 2, 3 or 4) and shade your answer on the Optical Answer Sheet.
(20 marks)

1. 3 thousands, 57 tens, and 3 ones is _____.

- (1) 3060
- (2) 3573
- (3) 8703
- (4) 35 703

2. Which of the following is equivalent to $2\frac{5}{6}$?

- (1) $\frac{7}{6}$
- (2) $\frac{13}{6}$
- (3) $\frac{17}{6}$
- (4) $\frac{32}{6}$

3. In 52.79, what does the digit 7 stand for?

- (1) 7 tens
- (2) 7 ones
- (3) 7 tenths
- (4) 7 hundredths

4. Which of the following when divided by 6 gives a quotient of 3 and a remainder of 2?

- (1) 6
- (2) 9
- (3) 15
- (4) 20

5. Arrange the following numbers in ascending order.

2.10 2.01 2.21

- (1) 2.01 , 2.1 , 2.21
- (2) 2.1 , 2.01 , 2.21
- (3) 2.1 , 2.21 , 2.01
- (4) 2.21 , 2.1 , 2.01

6. What is the closest estimation of the reading shown?

- (1) 4750 g
- (2) 5225 g
- (3) 5500 g
- (4) 5750g

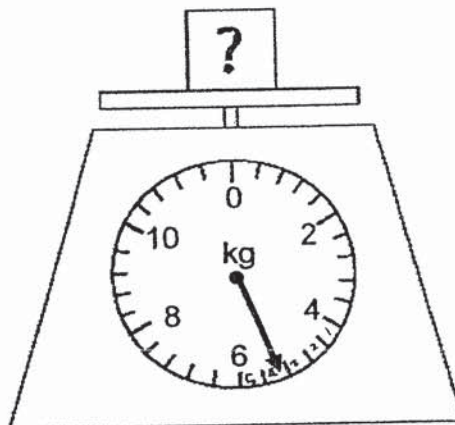

7. Peter had 15 sweets and 9 chocolates. What fraction of the snacks Peter had are chocolates?

(1) $\frac{2}{3}$

(2) $\frac{3}{5}$

(3) $\frac{3}{8}$

(4) $\frac{5}{8}$

8. In the figure below, the length of AD is thrice of AC. Find the area of triangle BCD.

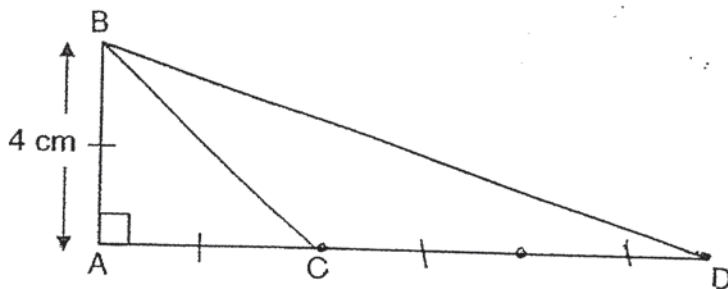

(1) 16 cm^2

(2) 24 cm^2

(3) 32 cm^2

(4) 48 cm^2

9. Find the value of $\frac{5w}{2} - w + 2$ when $w = 10$.

(1) 13

(2) 17

(3) 21

(4) 22

10. The figure below shows 2 parallelograms, ABCD and JKLM. Which of the following statements is true?

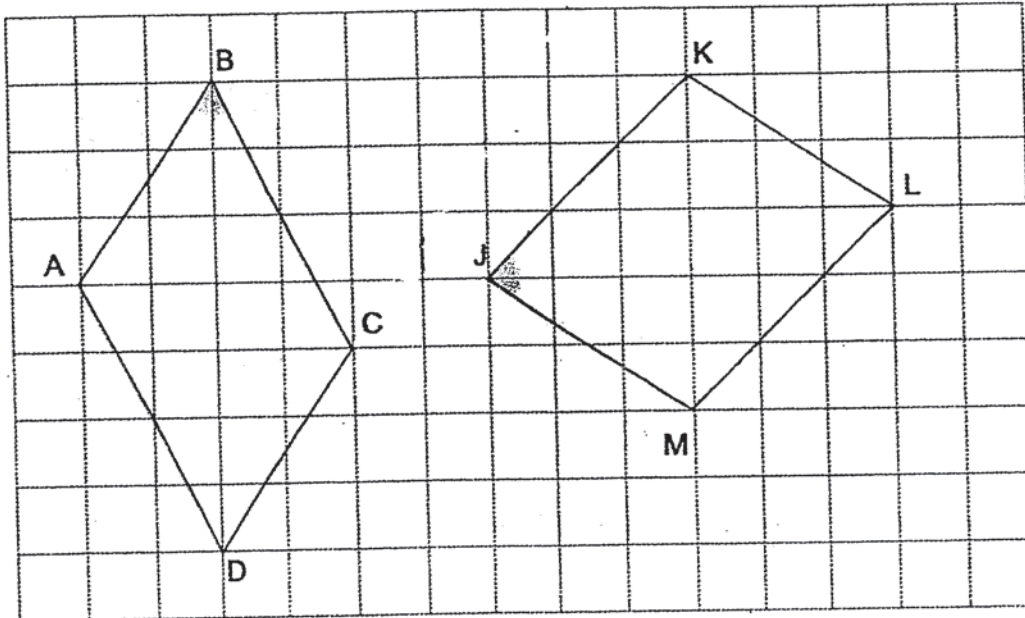

- (1) Line AB is parallel to line JK.
- (2) Line CD is perpendicular to Line JM.
- (3) Parallelogram JKLM is also a rectangle.
- (4) The angle $\angle ABC$ is equal to angle $\angle KJM$.

11. How many of the following shapes have at least a line of symmetry?

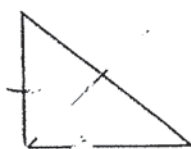

isosceles triangle

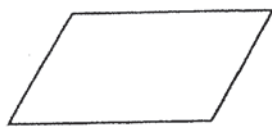

parallelogram



trapezium

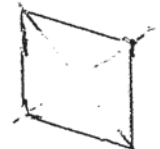

rhombus

- (1) 1
- (2) 2
- (3) 3
- (4) 4

12. The figure below is made up of a large semi-circle and 3 small identical semi-circles. Given that the length of AB is 12 cm, find the area of the shaded part in terms of π .

- (1) $12\pi \text{ cm}^2$
 (2) $18\pi \text{ cm}^2$
 (3) $24\pi \text{ cm}^2$
 (4) $48\pi \text{ cm}^2$

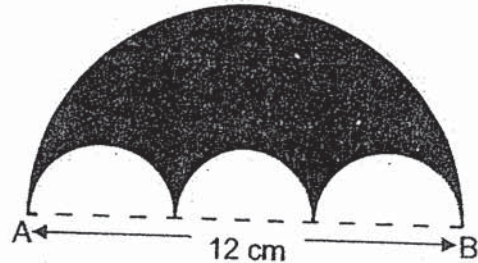

13. The distance between Point A and B is 480 m. John started cycling from point A to B at an average speed of 3 m/s while Peter started cycling from point B to A at an average speed of 2 m/s. How far apart will they be after 40 seconds?

- (1) 40 m
 (2) 80 m
 (3) 120 m
 (4) 280 m

14. The figure below shows 10 cubes glued together to form a solid. The entire solid, including the base, was then painted red. How many cubes have only 3 of the faces painted?

- (1) 1
 (2) 2
 (3) 3
 (4) 4

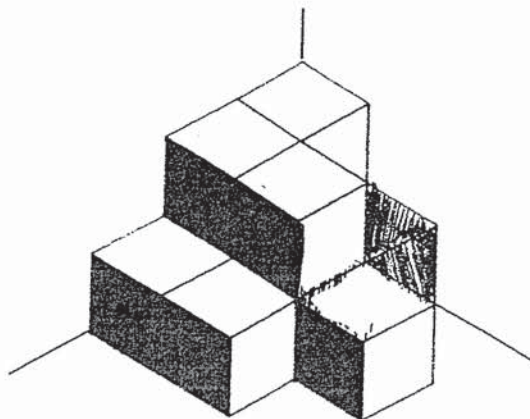

15. The bar graph below shows the result of 40 students voting for their favourite type of food, A to E.

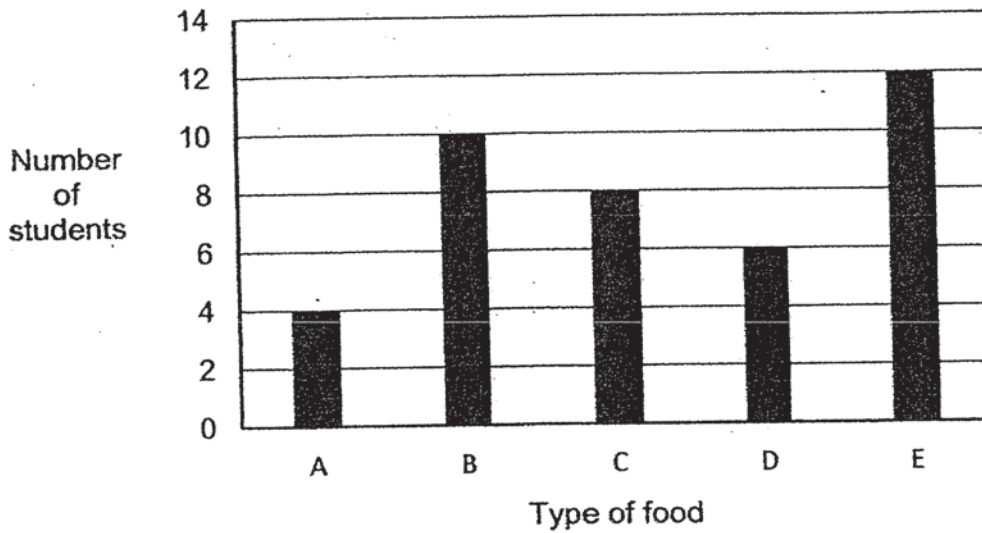

Which pie chart below best represents the information in the bar graph?

(1)

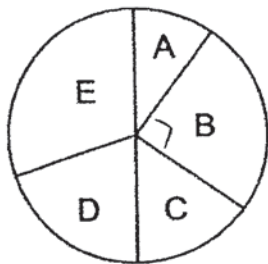

(3)

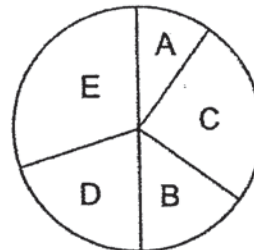

(2)

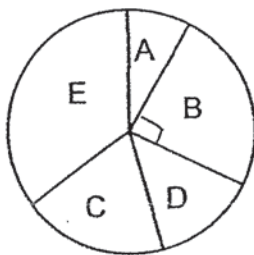

(4)

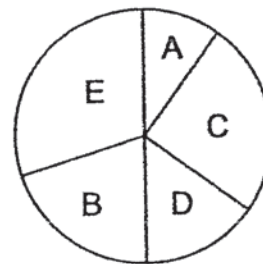

End of Booklet A

--	--	--	--	--	--	--	--	--



SINGAPORE CHINESE GIRLS' SCHOOL
PRELIMINARY EXAMINATION 2022

PRIMARY 6
MATHEMATICS
PAPER 1
(BOOKLET B)

Total Time for Booklets A and B: 1 h

Name : _____ ()

19 August 2022

Class : Primary 6 SY

Mathematics Teachers

SL / CTEO / LXJ /

INSTRUCTIONS TO CANDIDATES

1. Write your Index No. in the boxes at the top right hand corner
2. Do not turn over this page until you are told to do so.
3. Follow all instructions carefully.
4. Answer all questions.
5. Write your answers in this booklet.
6. The use of calculators is **NOT** allowed.

	Max Mark	Marks attained
Booklet B	25	

This booklet consists of 7 printed pages and 2 blank pages.

Booklet B

Questions 16 to 20 carry 1 mark each. Write your answers in the spaces provided.

For questions which require units, give your answers in the units stated. **(5 marks)**

Do not write in
this space

16. Express $7\frac{3}{5}$ as a decimal.

Ans: _____

17. Find the value of 2.6×40 .

Ans: _____

18. Express $\frac{11}{20}$ as a percentage.

Ans: _____ %

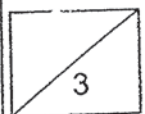

19. Measure and write down the size of $\angle u$.

Do not write in this space

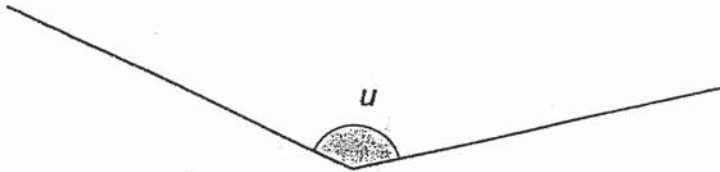

Ans: _____ °

20. 3 ℓ of water was poured into 4 glasses equally. What is the volume of water in each glass?

Ans: _____ ℓ

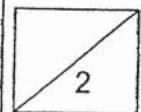

Questions 21 to 30 carry 2 marks each. Show your working clearly and write your answers in the spaces provided. For questions which require units, give your answers in the units stated. **(20 marks)**

Do not write in this space

21. John received the following test results from the school. What did John get for his Chinese Language marks if the average marks for all four subjects is 75?

Subjects	Marks
English Language	68
Mathematics	74
Science	83
Chinese Language	?

Ans: _____

22. Farhana took 8 minutes to walk home from school, which was 1.2 km away. What was her average speed?

Ans: _____ m/ min

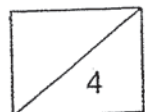

23. In the figure below, not drawn to scale, AD is parallel to BC. Find $\angle x$.

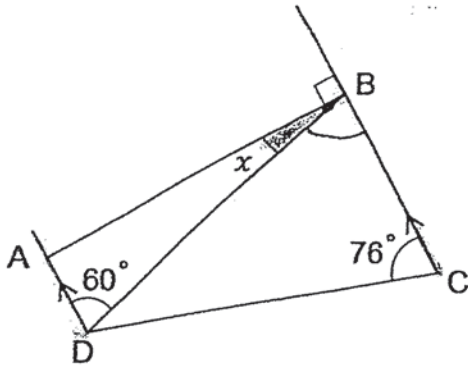

Do not write in this space

Ans: _____ °

24. Mr Chua had 36 kg of rice. He wanted to pack them into smaller bags of $\frac{4}{5}$ kg each. How many packets of rice will he get?

Ans: _____

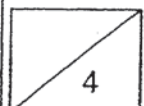

25. A vase was sold at a 40% discount for \$48. What was the original price of the vase before the discount?

Do not write in this space

Ans: \$ _____

26. A container completely filled with water weighed $1\frac{4}{5}$ kg. After pouring out $\frac{2}{3}$ of the water, it weighed 1kg. What was the mass of the container?

Ans: _____ kg

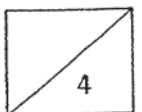

27. The net of a pyramid drawn below has 2 missing faces. Shade 2 faces to complete the net of the pyramid.

Do not write in this space

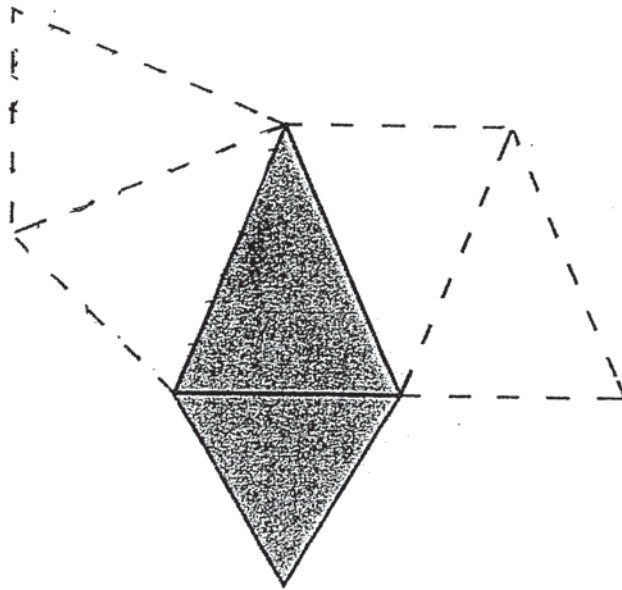

28. The figure below shows a semi-circle overlapping with a quadrant. Find the perimeter of the shaded part. (Take $\pi = \frac{22}{7}$)

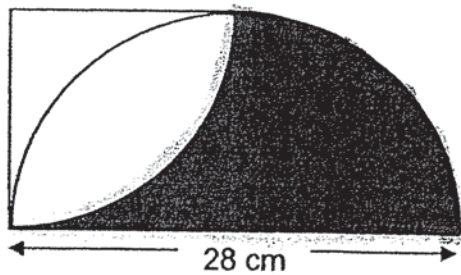

Ans: _____ cm

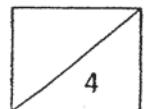

29. Charmaine read 30 pages on Monday and $\frac{1}{2}$ of the remaining book on Tuesday. She was then left with 20% of the book unread. How many pages does the book have?

Do not write in this space

Ans: _____

30. The figure below, not drawn to scale, shows a semi-circle with centre O and straight lines AD, OB and CD.

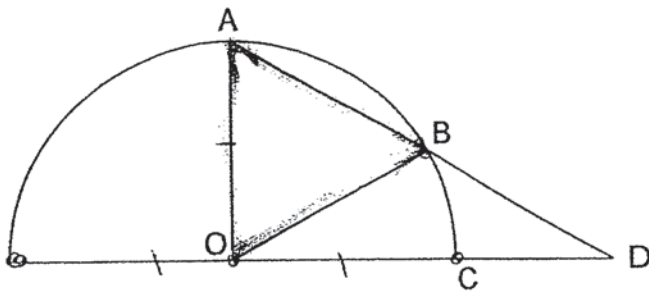

Each of the statements below is either true, false or not possible to tell from the information given. For each statement, put a tick ✓ to indicate your answer.

Statement	True	False	Not possible to tell
a) $\angle OAB$ is equal to $\angle OBA$.			
b) Triangle OAB is an equilateral triangle.			

End of Booklet B

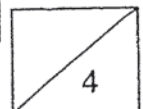

BLANK PAGE

--	--	--	--	--	--	--



SINGAPORE CHINESE GIRLS' SCHOOL
PRELIMINARY EXAMINATION 2022

PRIMARY 6
MATHEMATICS
PAPER 2

Time : 1 h 30 min

Name : _____ ()

19 August 2022

Class : Primary 6 SY

Mathematics Teachers

SL / CTEO / LXJ / KYS

INSTRUCTIONS TO CANDIDATES

1. Write your Index No. in the boxes at the top right hand corner
2. Do not turn over this page until you are told to do so.
3. Follow all instructions carefully.
4. Answer all questions.
5. Write your answers in this booklet.
6. The use of approved calculators is allowed.

		Max Mark	Marks attained
Paper 1	Booklet A	20	
	Booklet B	25	
Paper 2		55	
Total Marks		100	

Parent's Signature

This booklet consists of 14 printed pages and 2 blank pages.

Questions 1 to 5 carry 2 marks each. Show your working clearly and write your answers in the spaces provided. For questions which require units, give your answers in the units stated. (10 marks)

Do not write in this space

1. A crate contains apples, oranges and pears. $\frac{1}{2}$ of the fruits are pears. The ratio of the number of apples to oranges is 3 : 4 . What is the ratio of the number of pears to the number of oranges?

Ans: _____

2. The exchange rate for Singapore dollar (SGD) to Malaysia ringgit (MYR) is 10 SGD = 32.35 MYR. How much MYR will I get if I exchange 220 SGD?

Ans: MYR _____

3. The figure below, not drawn to scale, shows a square in a right-angle triangle. Find the area of the shaded part.

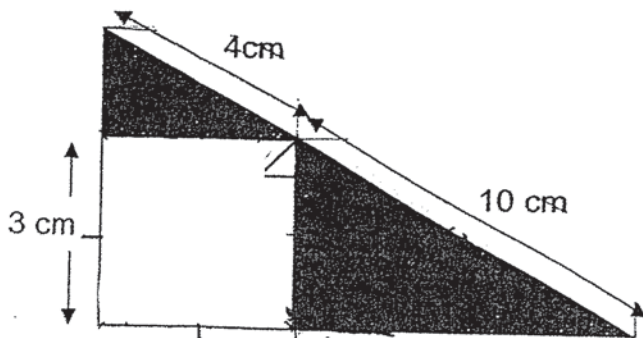

Ans: _____ cm²

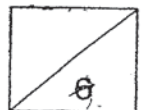

4. Water was flowing out from a leaking tap at a rate of 270ml per minute, filling up the container shown below. It took 27 minutes for the container to be completely filled with water. What is the height of the container?

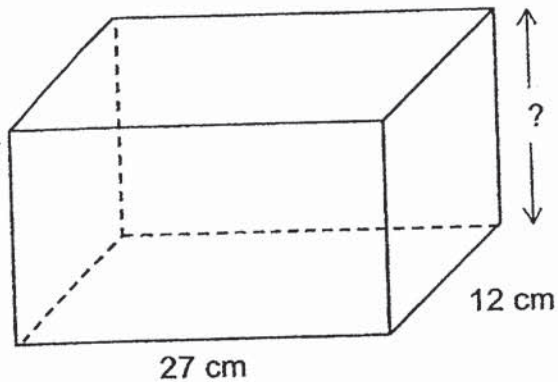

Do not write in this space

Ans: _____ cm [2]

5. Triangle ABC is drawn on the square grid as shown below. By joining dots on the grid with straight lines,
- draw and label a trapezium CABF such that the length of BF is half of AC.
 - draw and label Triangle ABD such that its area is half of Triangle ABC. Triangle ABD must not overlap with trapezium CABF.

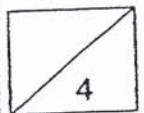
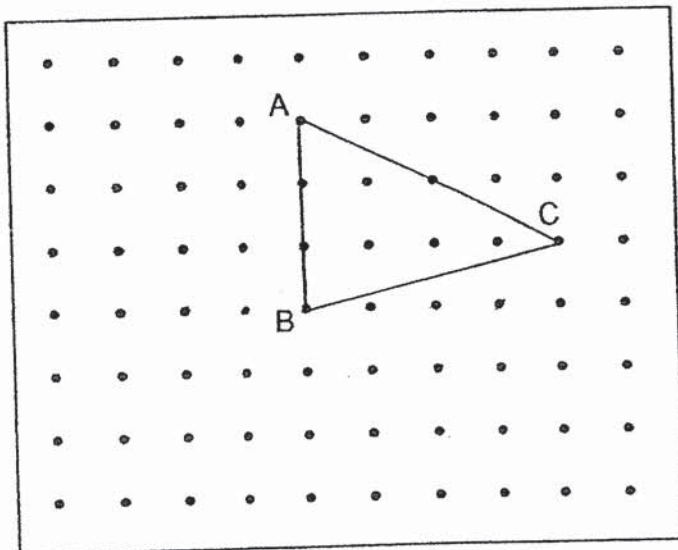

For questions 6 to 17, show your working clearly and write your answers in the spaces provided. The number of marks available is shown in brackets [] at the end of each question or part-question. (45 marks)

Do not write in this space

6. Helen is $(y + 8)$ years old now. She is 3 years older than Bonny.
(a) What will be their total age in 2 years' time in terms of y ?

Ans: (a) _____ [2]

- (b) If $y = 5$, find their total age in 2 years' time.

Ans: (b) _____ [1]

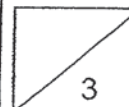

7. The bar graph below shows the number of cakes a bakery sold from January to March.

Do not write in this space

- (a) The number of cakes sold in March was 15% of the total number of cakes sold from January to April.
What was the total number of cakes sold from January to April?

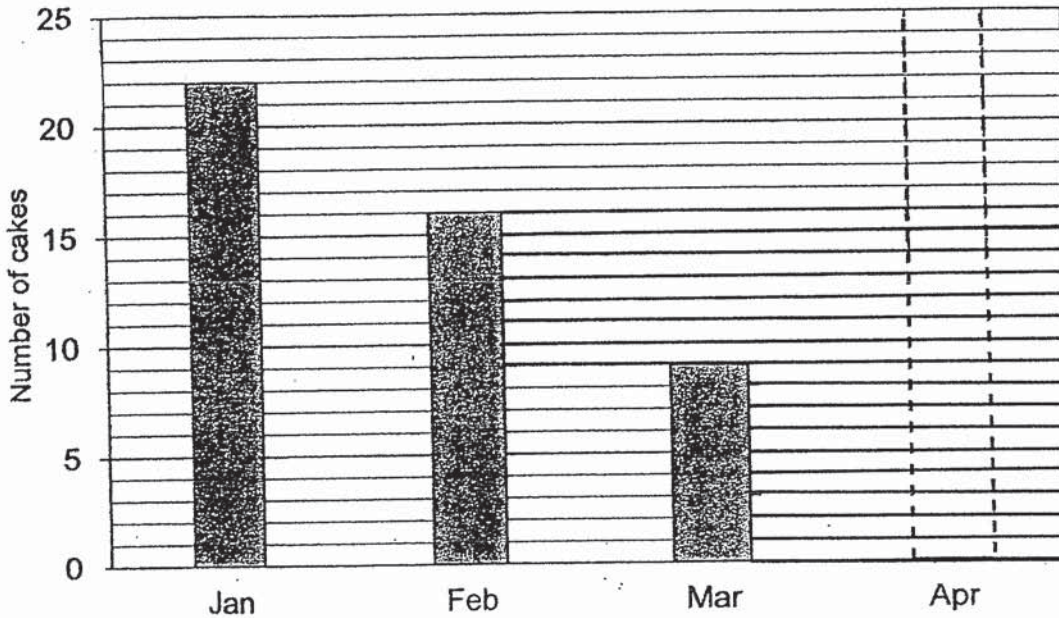

Ans: (a) _____ [2]

- (b) Draw and shade the bar representing the number of cakes sold in April above. [1]

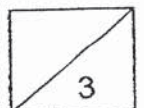

8. In the figure below, not drawn to scale, ABCD is a square with a length of 14 cm.
 Given that BCF is a straight line, and the area of triangle AED is 36.75 cm^2 ,
 find the area of triangle EFD:

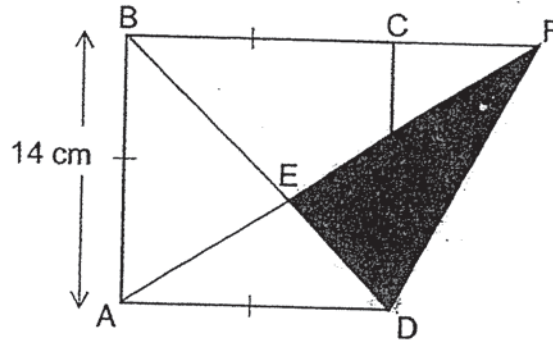

Do not write in
 this space

Ans: _____ [3]

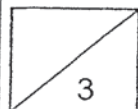

9. In the figure below, not drawn to scale, ABCD is a rectangle. EF is parallel to BD and $AD = DG$.

Do not write in this space

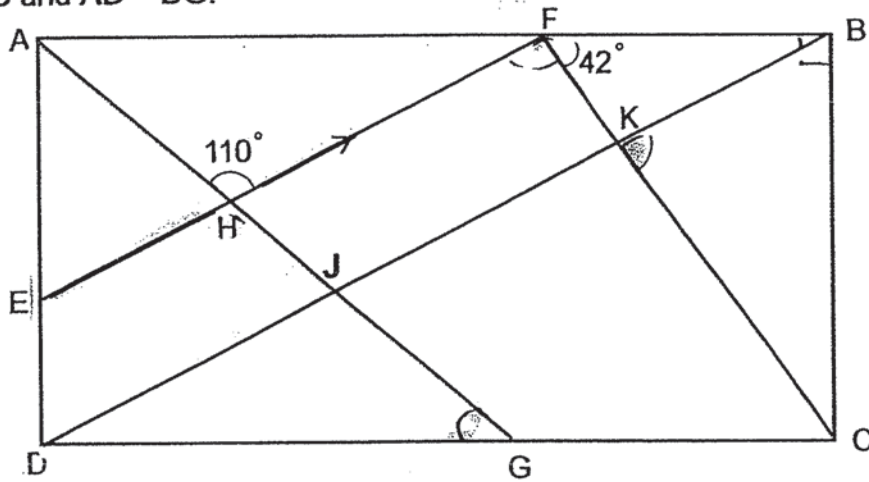

- (a) Find $\angle AFE$.

Ans: (a) _____ [1]

- (b) Find $\angle BKC$.

Ans: (b) _____ [2]

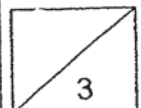

10. The cost of an adult ticket to a concert was \$68.80. The cost of a child ticket was \$32.80. The total amount of money collected from ticket sales was \$28 100 for a capacity of 500 people. How many adults attended the concert?

Do not write in this space

Ans: _____ [4]

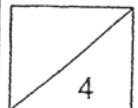

11. A baker had a 50-kg sack of flour at first. The graph shows the amount of flour left at the end of each day for 5 days.

Do not write in this space

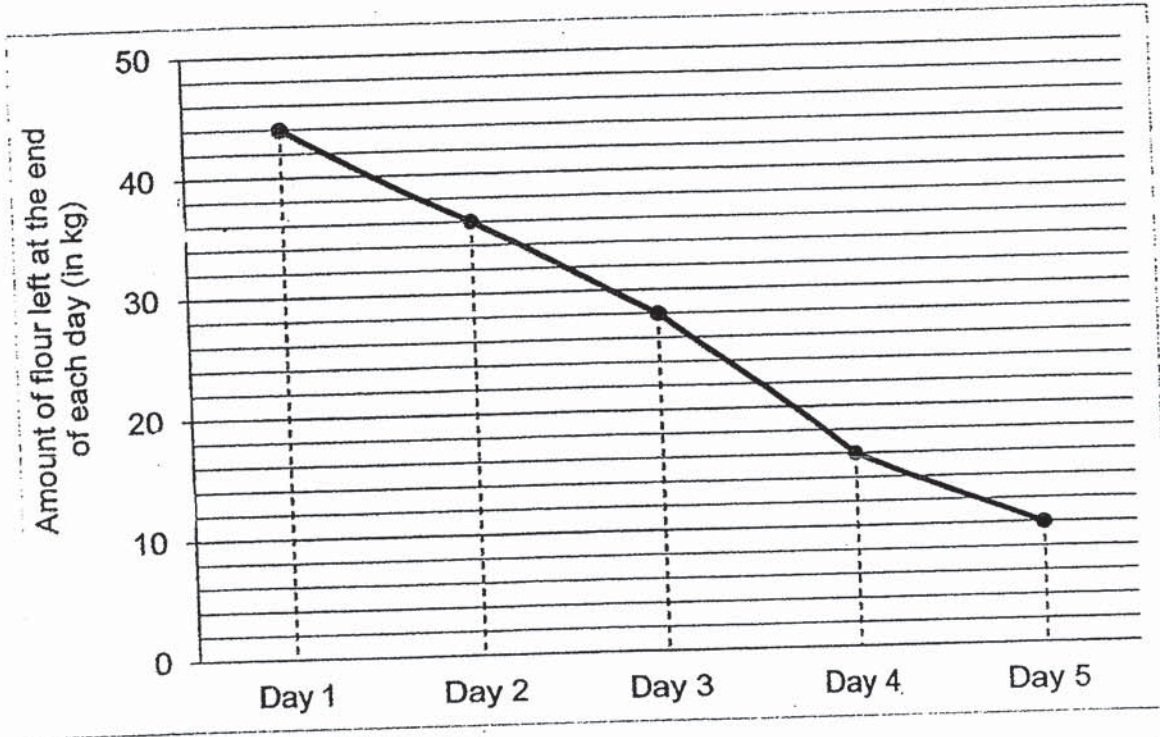

- (a) Which day did the baker use the greatest amount of flour?

Ans: (a) _____ [1]

- (b) What percentage of the 50-kg sack of flour was used by day 5?

Ans: (b) _____ [2]

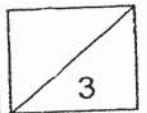

12. In the figure below, ABCD is a square. ADF is an equilateral triangle and DECF is a trapezium. $DE \parallel FC$, $\angle DEC = 50^\circ$.

- (a) Find ~~$\angle DCF$~~ $\angle DCE$
 (b) Find $\angle BFC$

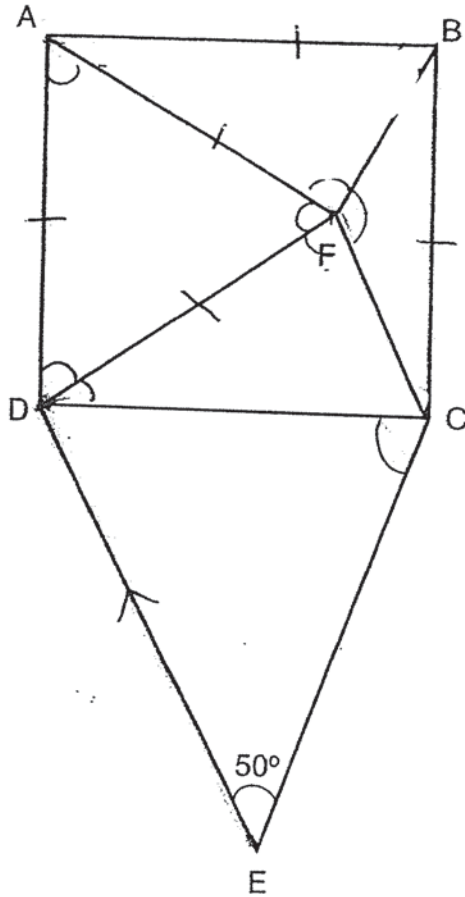

Do not write in this space

Ans: (a) _____ [2]

(b) _____ [2]

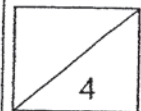

13. Fred, Gerald and Harry shared \$123 altogether. At a toy shop, Fred spent $\frac{2}{5}$ of his money, Gerald spent $\frac{3}{4}$ of his money and Harry spent $\frac{2}{3}$ of his money. Fred and Gerald spent the same amount of money and Harry spent twice of what Fred spent. Find the amount of money Gerald had at first.

Do not write in this space

Ans. _____ [4]

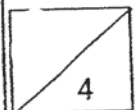

14. Mdm Pang baked some cookies. She gave $\frac{1}{4}$ of it to her relatives and gave 80 cookies to her friends. She was left with $\frac{1}{3}$ of it.
(a) How many cookies had Mdm Pang left?

Do not write in this space

Ans: (a) _____ [3]

- (b) Mdm Pang packed the leftover cookies into 10 small and large bags. The number of cookies in each large bag is twice the number of cookies in each small bag. How many large bags of cookies were there?

Ans: (b) _____ [2]

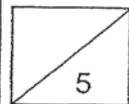

15. Celine took a square piece of paper and cut along the dotted line shown below. As a result, she got a small square of area 49 cm^2 and 8 identical right-angled triangles. Triangle EFG is one such right-angled triangles.

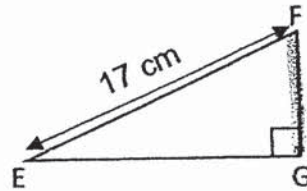
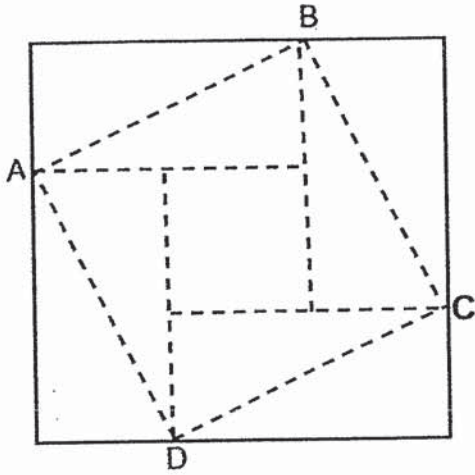

(a) Find the area of the square ABCD.

Ans: (a) _____ [1]

(b) Find the length of FG.

Ans: (b) _____ [4]

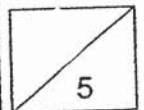

Do not write in this space

16. There were 75 more children than adults at a funfair on Saturday. On Sunday, the number of children increased by 24% while the number of adults decreased by 15%. There were 2810 people on Sunday. How many people were there at the funfair on Saturday?

Do not write in
this space

Ans: _____ [4]

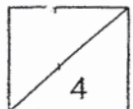

17. The diagram below shows figures made up of dots and lines.

Do not write in this space

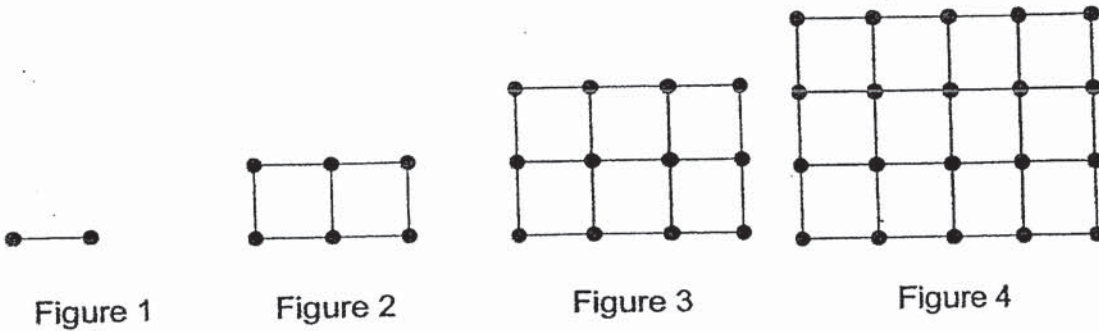

(a) Complete the table below.

Figure No.	Number of dots	Number of lines
1	2	1
2	6	7
3	12	17
4	20	31
5		

[2]

(b) Which figure no. will it be where there are 156 dots?

Ans: (b) _____ [2]

End of Paper 2

~ Please check your work thoroughly. ~

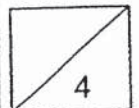

YEAR : 2022
 LEVEL : PRIMARY 6
 SCHOOL : SINGAPORE CHINESE GIRLS' SCHOOL
 SUBJECT : MATHEMATICS
 TERM. : PRELIMINARY EXAMINATION

PAPER 1 (BOOKLET A)

Q1	2	Q2	3	Q3	3	Q4	4	Q5	1
Q6	2	Q7	3	Q8	1	Q9	2	Q10	2
Q11	2	Q12	1	Q13	4	Q14	2	Q15	2

(BOOKLET B)

Q16	7.6
Q17	104
Q18	55%
Q19	142°
Q20	%L
Q21	Average = 75 $68 + 74 = 142$ $142 + 83 = 225$ $75 \times 4 = 300$ $300 - 225$
Q22	$1.2 \text{ km} = 1200 \text{ m}$ $1200 \div 8 = 150 \text{ m/min}$
Q23	$180 - 90 = 90$ $90 - 60 = 30^\circ$
Q24	$36 \div 4/5 = 36 \div 4$ $= 45$
Q25	$60\% : \$48$ $1\% : 48 \div 60$ $= 0.8$ $0.8 \times 100 = \$80$
Q26	$2/3 \text{ of water} : 1 - \frac{1}{5} = 4/5$ $1/3 \text{ of water} : \frac{4}{5} \times \frac{1}{2}$ $= \frac{2}{5}$ $1 - \frac{2}{5} = \frac{3}{5} \text{ kg}$

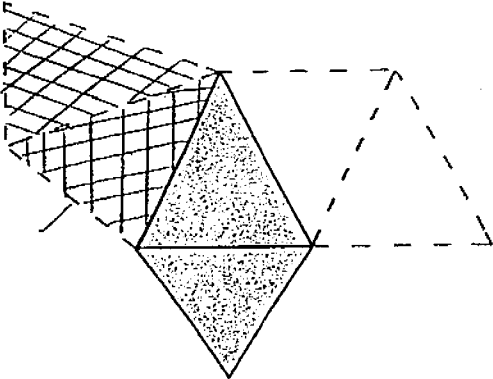
Q27	
Q28	<p>Semicircle : $2\pi r \times \frac{1}{2}$ $= 2\left(\frac{22}{7}\right) \times 14 \times \frac{1}{2}$ $= 44$ $44 + 28 = 72\text{cm}$</p>
Q29	<p>$5u - 2u = 3u$ $3u = 30$ $u = 30 \div 3$ $= 10$ $5u = 10 \times 5$ $= 50 \text{ pages}$</p>
Q30	<p>a) True ✓ b) Not possible to tell ✓</p>

Maths Prelims, 2022 Paper 2

1) P: Total A: 0 | A+0
 1: 2 3:4 | 7
 = 7:14

P: 0 — 7:4

2) SGD 10 — MYR 32.35
 x22 (SGD 220 — MYR 32.35 x 22
 = MYR 711.70)

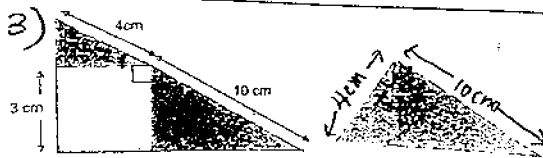

$\angle x + \angle y = 90^\circ$
 Shaded area — $\frac{1}{2} \times 10 \text{ cm} \times 4 \text{ cm}$
 = 20 cm²

4) Height — $\frac{27 \times 270 \text{ cm}^3}{27 \text{ cm} \times 12 \text{ cm}} = 22\frac{1}{2} \text{ cm}$

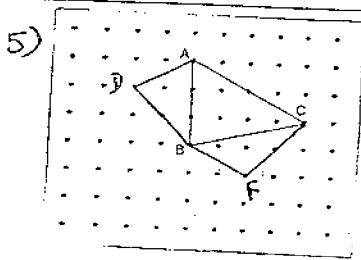

6a) Bonny now — $y + 8 - 3 = y + 5$
 Total now — $(y + 8 + y + 5 + 2 + 2) \text{ yrs}$
 = $(2y + 17) \text{ yrs}$

6b) Total — $(2 \times 5 + 17) \text{ yrs}$
 = 27 yrs

7a) 15% — 9
 100% — $\frac{9}{15} \times 100 = 60$

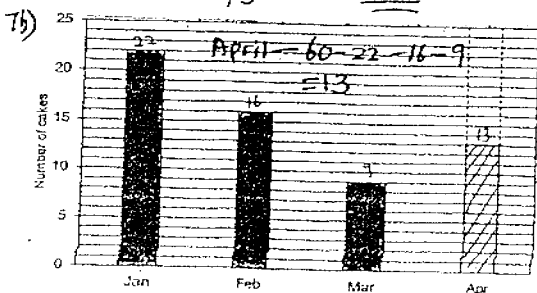

8) Area of AFD — $\frac{1}{2} \times 14 \text{ cm} \times 14 \text{ cm} = 98 \text{ cm}^2$
 Area of EFD — $98 \text{ cm}^2 - 36.75 \text{ cm}^2 = 61.25 \text{ cm}^2$

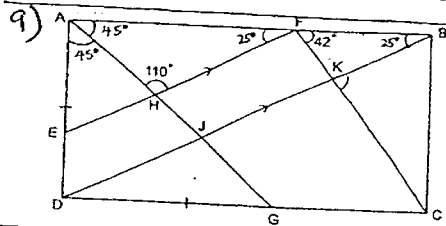

a) $\angle AFE$
 — $180^\circ - 110^\circ - 45^\circ$
 = 25°

b) $\angle BKC$ — $42^\circ + 25^\circ$
 = 67°

10) If all 500 were children, amount collected will be — $\$32.80 \times 500 = \16400

Diff in total — $\$28100 - \$16400 = \$11700$

Diff between 1 adult and 1 child ticket — $\$68.80 - \$32.80 = \$36$

No. of adults — $\frac{\$11700}{\$36} = 325$

11a) 4 (steepest line between Day 3 and Day 4)

11b) Used — $50 \text{ kg} - 10 \text{ kg} = 40 \text{ kg}$

% used — $\frac{40 \text{ kg}}{50 \text{ kg}} = \frac{80}{100} = 80\%$

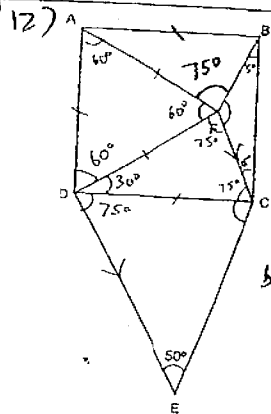

$\angle FDC$ — $90^\circ - 60^\circ = 30^\circ$

$\angle DCF$ — $\frac{180^\circ - 30^\circ}{2} = 75^\circ$

a) $\angle DCE$ — $180^\circ - 75^\circ - 50^\circ$
 = 55°

b) $\angle BFC$ — $360^\circ - 75^\circ - 75^\circ - 60^\circ$
 = 150°

13) $\frac{2}{5}$ of F = $\frac{3}{4}$ of G

$\frac{6}{15}$ of F = $\frac{6}{8}$ of G

Harry — $\frac{2}{3} = \frac{12}{18}$

Fred — 15u

Gerald — 8u

Harry — 18u

Total — $15u + 8u + 18u = 41u$

41u — \$123

1u — $\frac{\$123}{41} = \3

8u — $\$3 \times 8 = \24

14a) Gave to relatives — $\frac{1}{4} = \frac{3}{12}$

Left — $\frac{1}{3} = \frac{4}{12}$

Gave to friends — $1 - \frac{3}{12} - \frac{4}{12}$
 $= \frac{5}{12}$

$\frac{5}{12} — 80$

$\frac{1}{12} — \frac{80}{5} = 16$

$\frac{4}{12} — 16 \times 4 = \underline{\underline{64}}$
 (left)

14b) 9 small + 1 large — 10 bags
 (2 small) x

8 small + 2 large — 10 bags
 (4 small) x

7 small + 3 large — 10 bags
 (6 small) x

6 small + 4 large — 10 bags
 (8 small) x

5 small + 5 large — 10 bags
 (10 small) x

4 small + 6 large — 10 bags
 (12 small) x

$4 + 12 = 16$, 64 is divisible by 16

Ans: 6

15a)

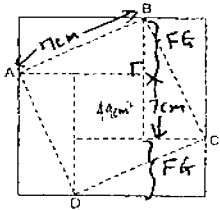

ABCD —
 $17\text{cm} \times 17\text{cm}$
 $= \underline{\underline{289\text{cm}^2}}$

b) 4 triangles — $289\text{cm}^2 - 49\text{cm}^2$
 $= 240\text{cm}^2$

8 triangles — $240\text{cm}^2 \times 2 = 480\text{cm}^2$

Area of large square — $480\text{cm}^2 + 49\text{cm}^2$
 $= 529\text{cm}^2$

Length of small square — $\sqrt{49\text{cm}^2} = 7\text{cm}$

Length of large square — $\sqrt{529\text{cm}^2} = 23\text{cm}$

FG — $\frac{23\text{cm} - 7\text{cm}}{2} = \underline{\underline{8\text{cm}}}$

16) Saturday

C	100%	75
A	100%	

Sunday

children — 124% and $75 + \frac{24}{100} \times 75$
 $= 93$

Adults — 85%

Total on Sunday — 124% + 85% and 93 children
 $= 209\%$ and children

209% — $2810 - 93$
 $= 2717$

1% — $\frac{2717}{209} = 13$

200% — $13 \times 200 = 2600$

Saturday — $2600 + 75 = \underline{\underline{2675}}$

17) No. of dots — Figure number x (Figure number + 1)

No. of lines — (Figure number)² + (Fig. no. - 1) x (Fig. no. + 1)

a) No. of dots in figure 5 — $5 \times (5 + 1)$
 $= \underline{\underline{30}}$

No. of lines in figure 5 — $5 \times 5 + (5 - 1) \times (5 + 1)$
 $= 5 \times 5 + 4 \times 6$
 $= \underline{\underline{49}}$

b) Figure 10 — $10 \times 11 = 110$

Figure 11 — $11 \times 12 = 132$

Figure 12 — $12 \times 13 = 156$

↑ Answer

END
 5.

