

# METHODIST GIRLS' SCHOOL

Founded in 1887



PRELIMINARY EXAMINATION 2022

PRIMARY 6

SCIENCE

BOOKLET A

Total Time for Booklets A and B: 1 hour 45 minutes

## INSTRUCTIONS TO CANDIDATES

Do not turn over this page until you are told to do so.

Follow all instructions carefully.

Answer all questions.

Shade your answers in the Optical Answer Sheet (OAS) provided.

Name: \_\_\_\_\_ ( )

Class: Primary 6.   1  

Date: 23 August 2022

This booklet consists of 19 printed pages including this page.

For each question from 1 to 28, four options are given. One of them is the correct answer.  
 Make your choice (1, 2, 3 or 4). Shade the correct oval on the Optical Answer Sheet (OAS). [56 marks]

- 1 Three students observed and compared the following organisms.



Organism A



Organism B



Organism C

The students then made the following statements.

- Ash: B can move from place to place but not A and C.  
 Bob: All the organisms need oxygen.  
 Cate: A and C can make their own food while B cannot.

Which of the above pupil(s) had made the correct statement(s)?

- (1) Ash only  
 (2) Bob only  
 (3) Ash and Bob only  
 (4) Bob and Cate only
- 2 The diagrams below show four fruits produced by plants that are found in habitat K.

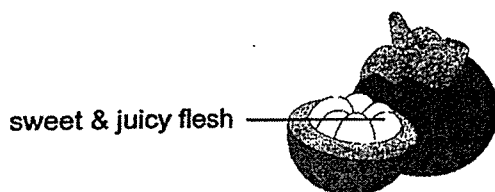

sweet & juicy flesh

Plant P

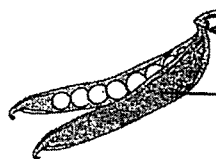

pod-like structure

Plant Q

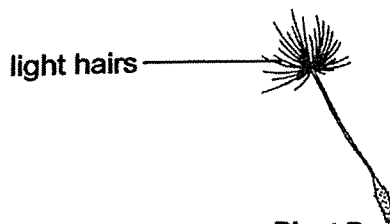

light hairs

Plant R



stiff hairs

Plant S

If a large number of animals in habitat K were hunted and killed, which plant populations will decrease in numbers most quickly after some time?

- (1) P and Q  
 (2) P and S  
 (3) Q and R  
 (4) R and S

(Go on to the next page)

- 3 The diagram below shows how food and water are transported to different parts of a flowering plant.

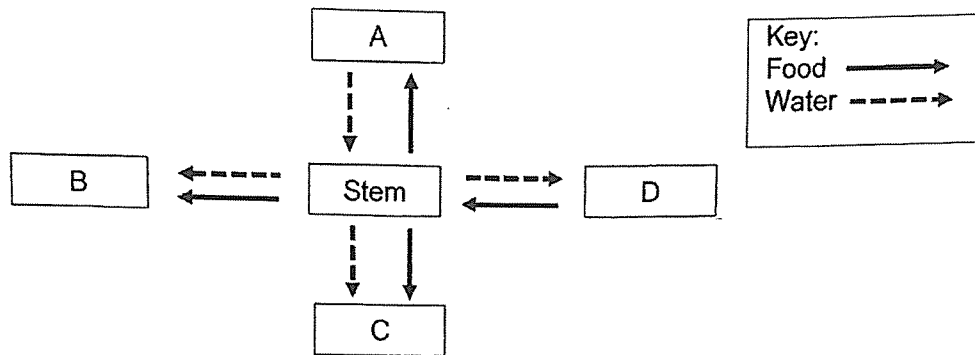

Which of the following correctly identifies the parts of the plant?

	A	B	C
(1)	flower	roots	leaves
(2)	fruits	flower	roots
(3)	roots	leaves	flower
(4)	roots	flower	fruit

- 4 The diagram below shows the cell of a green plant.

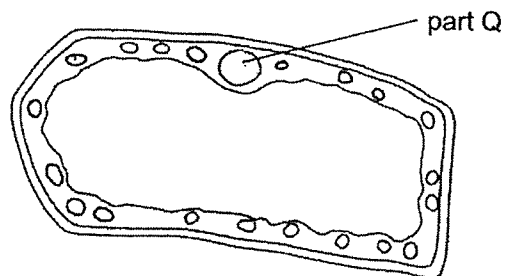

What is the main function of part Q?

- (1) It traps sunlight to make food.
- (2) It gives the cell a fixed shape.
- (3) It controls all activities in the cell.
- (4) It controls movement of substances entering or leaving the cell.

- 5 Several people were trapped in a lift for 30 min. There was no fresh air entering the lift.

Which of the following shows the correct change in the amount of gases in the lift after 30 min?

	carbon dioxide	oxygen	water vapour
(1)	increase	decrease	increase
(2)	decrease	increase	no change
(3)	increase	decrease	no change
(4)	decrease	increase	increase

- 6 The table below compares the sexual reproduction of humans and flowering plants.

	Humans	Flowering plants
Part where the male reproductive cells are stored	W	X
Part where the female reproductive cells are stored	Y	ovary
Process by which the male reproductive cell fuses with the female reproductive cell	fertilisation	Z

Which one of the following correctly identifies W, X, Y and Z?

	W	X	Y	Z
(1)	testis	stigma	womb	fertilisation
(2)	testis	anther	ovary	fertilisation
(3)	ovary	stigma	womb	pollination
(4)	testis	anther	ovary	pollination

7 The diagram below shows a seedling.

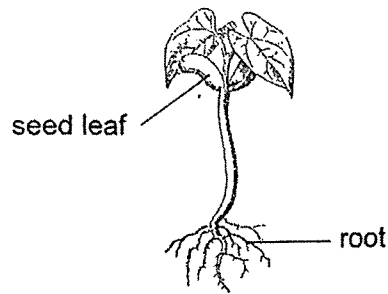

Which of the following graphs correctly shows the changes in the mass of the seed leaves and the seedling over the next few days?

Legend:

— seedling

----- seed leaves

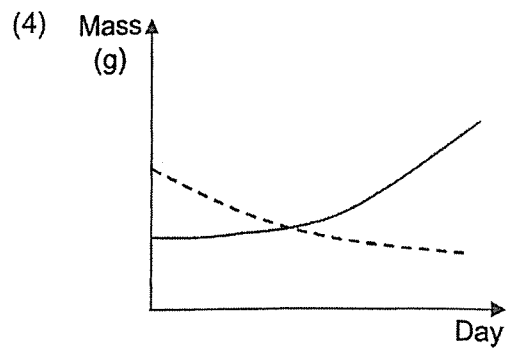
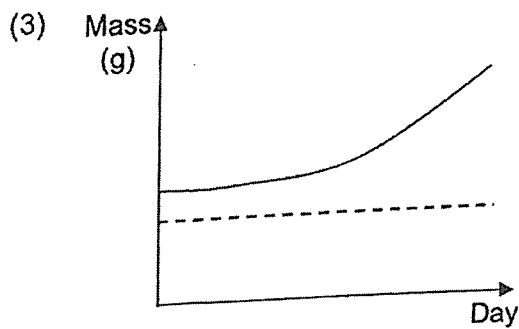
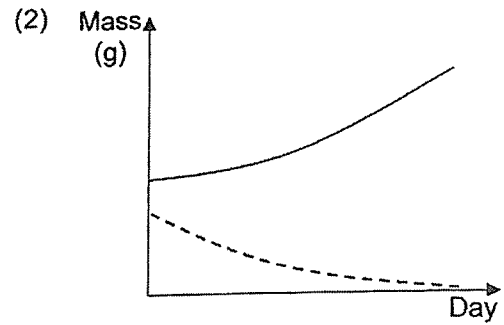
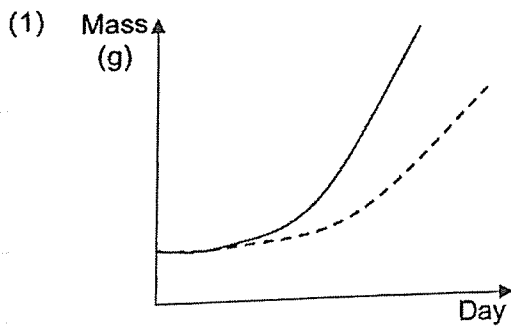

(Go on to the next page)

- 8 Study the diagram carefully.

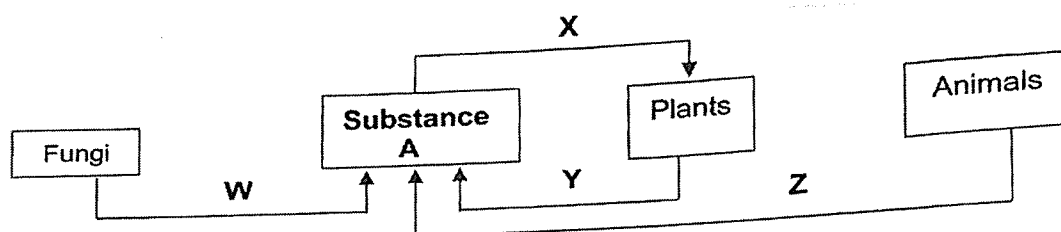

Which of the following is correct?

	Decomposition	Photosynthesis	Substance A
(1)	W	X	Oxygen
(2)	W and Z	X	Carbon dioxide
(3)	W	Y	Oxygen
(4)	W and Z	Y	Carbon dioxide

- 9 Bird G can dive into the sea water to catch fish and other small marine animals as shown in the picture below.

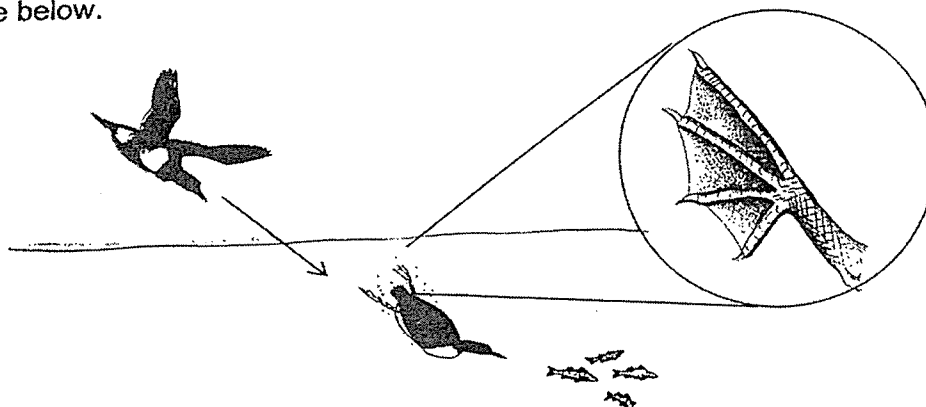

Which of the following statements best describes bird G's adaptation to enable it to swim quickly in the water?

- (1) Webbed feet and strong wings
- (2) Webbed feet and hollow bones
- (3) Streamlined body and webbed feet
- (4) Streamlined body and waterproof feathers

(Go on to the next page)

10 Study the food web as shown below.

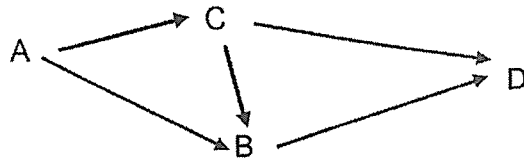

Which of the following will happen if there is a huge increase in the population of B?

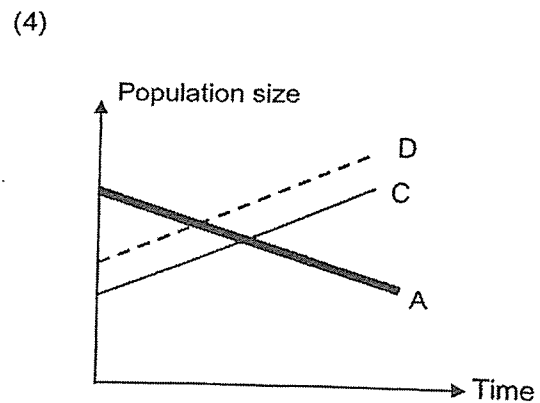
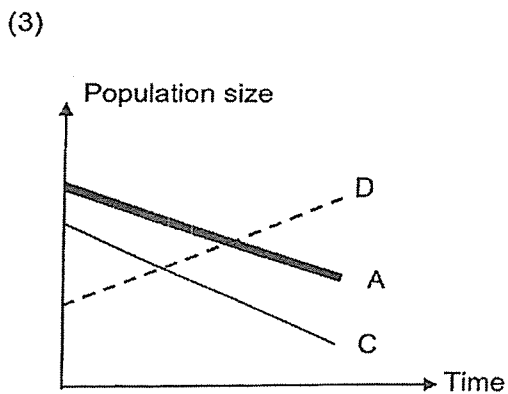
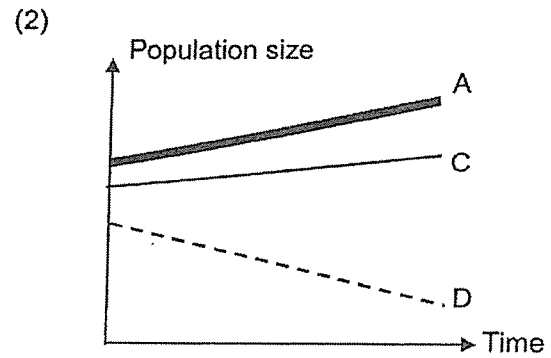
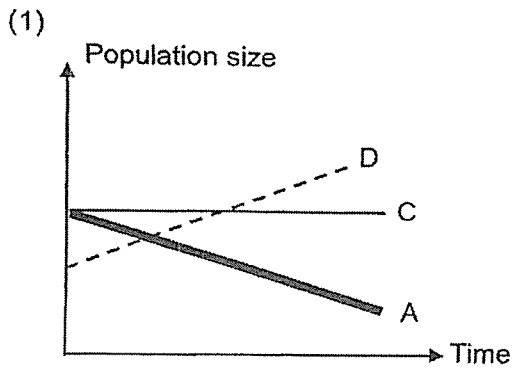

11 Which of the following is an impact of increased greenhouse gases in the atmosphere?

- (1) more floods
- (2) more deforestation
- (3) more water pollution
- (4) more carbon dioxide in the air

(Go on to the next page)

- 12 Susie wanted to find out how the intensity of light affects the rate of photosynthesis) of plant T. She set up an experiment in a dark room as shown below.

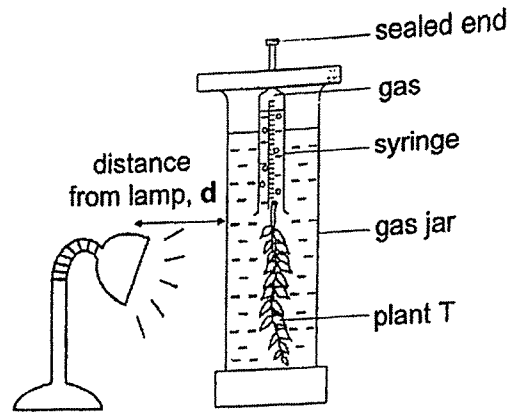

Susie measured and recorded the amount of gas collected when the lamp was switched on. She repeated the experiment by varying the distance,  $d$ . Which of the following graphs shows the most likely result?

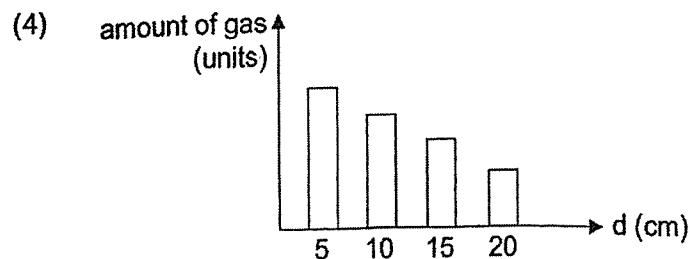
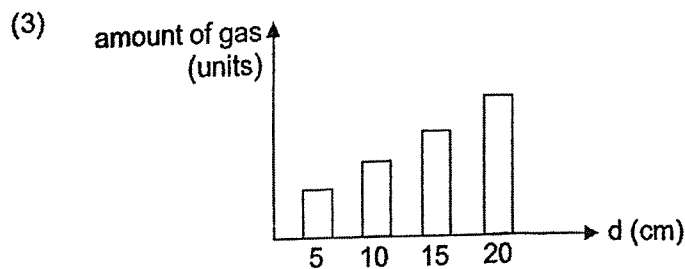
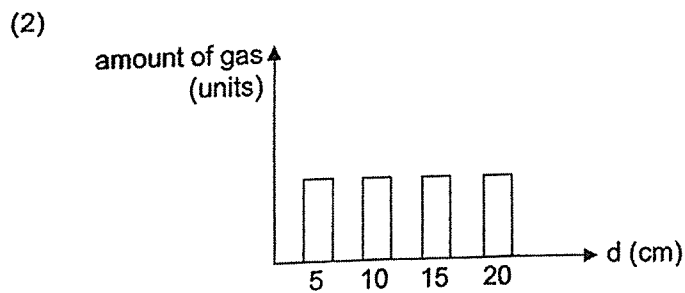
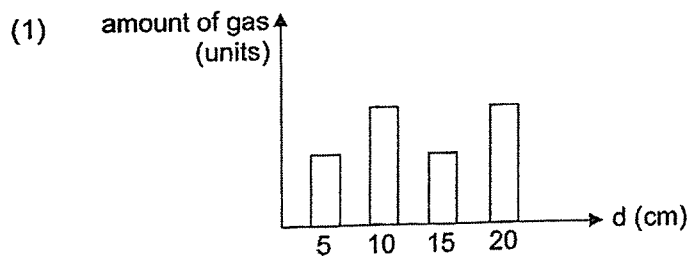

(Go on to the next page)



- 13 Ken placed seeds in four identical bottles at room temperature as shown in set-ups A, B, C and D below.

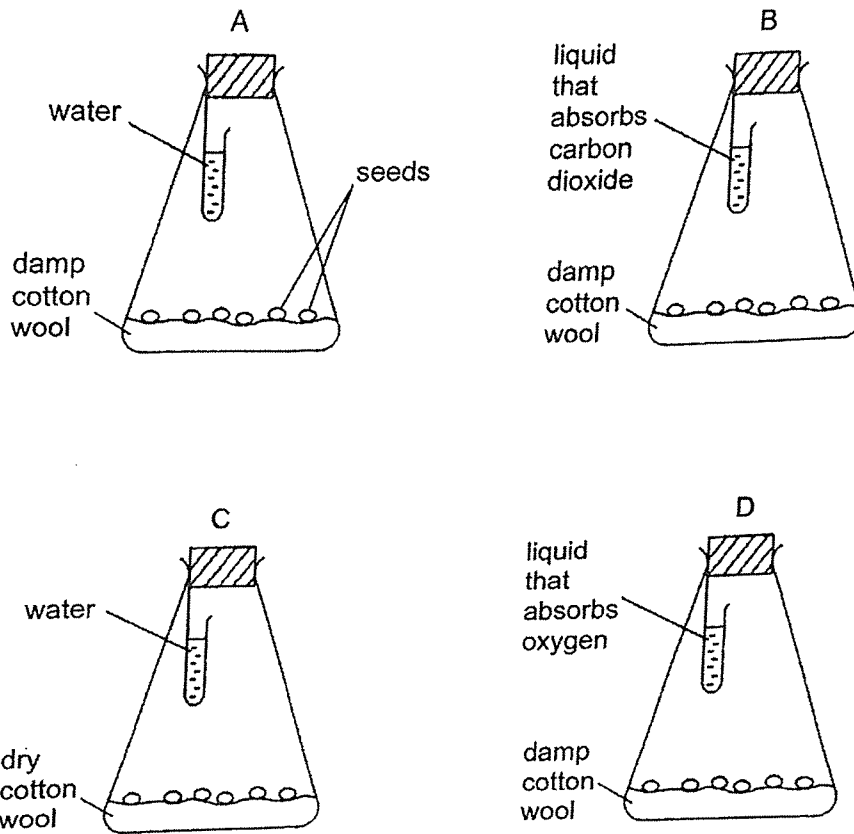

In which of the set-up(s) would the seeds most likely germinate?

- (1) A only
- (2) A and B only
- (3) B and C only
- (4) A, B and D only

(Go on to the next page)

- 14 The diagram below shows how blood flows in certain parts of the human body.

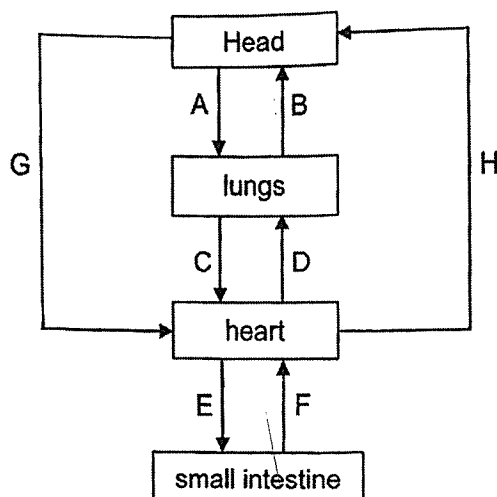

Which two arrows show the incorrect blood flow between the organs?

- (1) A and B only
  - (2) C and D only
  - (3) E and F only
  - (4) G and H only
- 15 Mrs Woo wore a surgical mask as she was having cough. The surgical mask helps to prevent her respiratory droplets from reaching other people around her when she coughs.

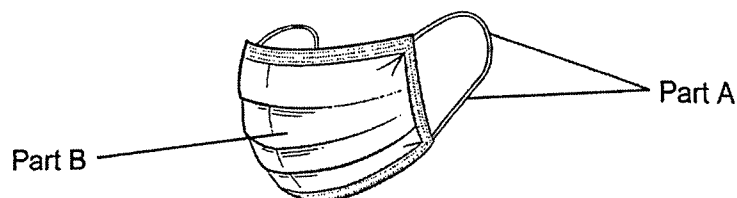

What are the properties of the materials used to make parts A and B so that the surgical mask can perform its function?

	A	B
(1)	flexible	waterproof
(2)	strong	absorbent
(3)	stiff	absorbent
(4)	flexible	stiff

16 Ailing filled four similar beakers, A, B, C and D, with different substances.

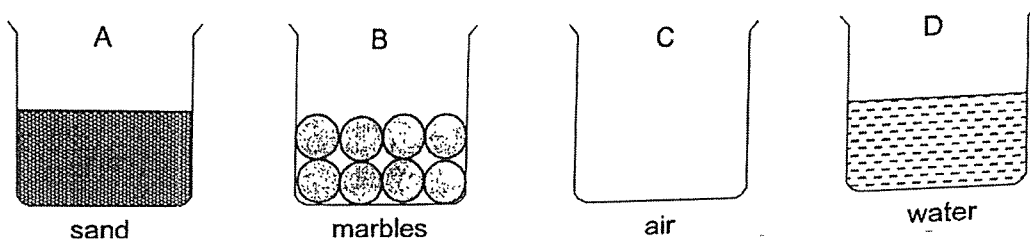

Ailing added water into each beaker at the same rate. She measured the time taken for water to overflow each beaker.

Which of the following shows the longest to shortest time for water to overflow the beaker?

- (1) B, D, A, C
- (2) C, B, A, D
- (3) C, A, B, D
- (4) D, A, B, C

17 Which of the following diagrams correctly shows how living things play a part in the water cycle?

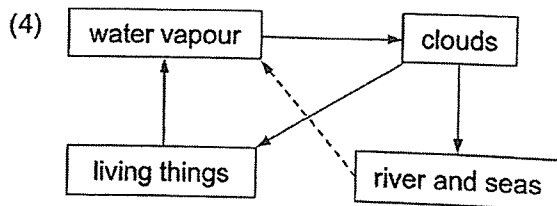
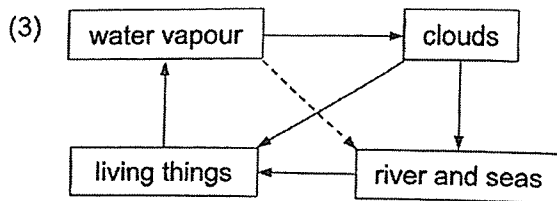
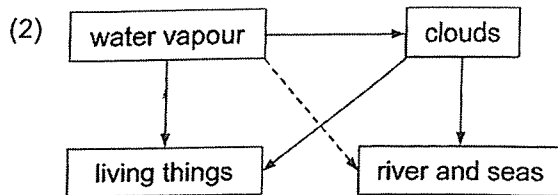
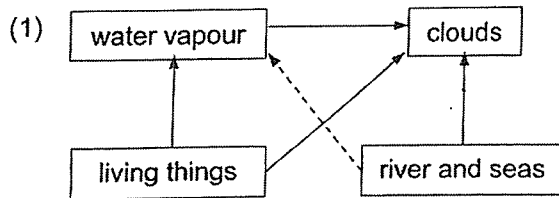

(Go on to the next page)

- 18 Study the four circuit diagrams below. All the batteries and bulbs are identical and in good working condition.

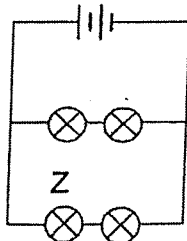

Circuit P

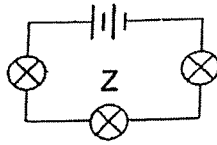

Circuit Q

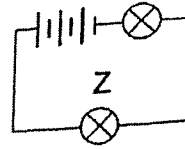

Circuit R

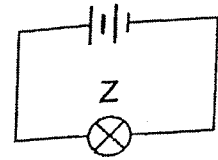

Circuit S

Arrange the circuits according to the brightness of bulb Z, from the dimmest to the brightest.

- (1) Q, P, R, S
  - (2) P, Q, S, R
  - (3) R, S, Q, P
  - (4) S, R, P, Q
- 19 James is sliding down a slide as shown below.

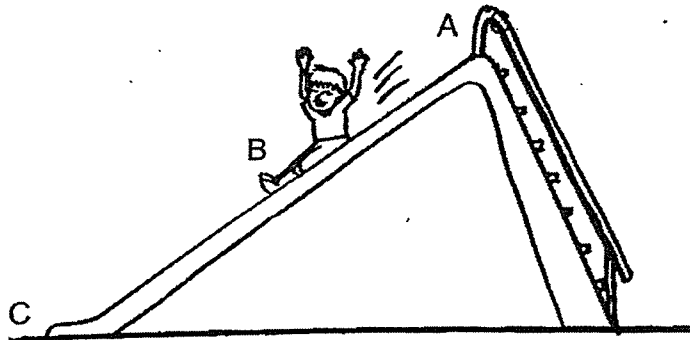

Which of the following statements is true about the gravitational force acting on James?

- (1) Gravitational force is greatest at position A
- (2) Gravitational force is the same at all positions
- (3) Gravitational force is greatest at position C when he stops
- (4) Gravitational force is least at position B when he is moving down

20 Study the table below.

Substance	State of substance at		
	25°C	78°C	100°C
A	solid	solid	solid
B	solid	liquid	liquid
C	solid	liquid	gas

Which of the following statements is definitely correct?

- (1) Substance C is water.
- (2) The melting point of substance B is 78°C.
- (3) Substance A has the highest boiling point.
- (4) Substance A has a higher freezing point than substance B.

21 The circuit below has three rods, W, X and Y, made of different materials.

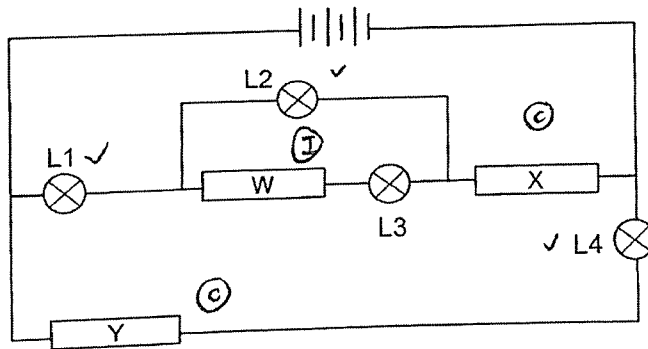

The only bulbs that lit up were L1, L2 and L4. Which of the following shows the most likely materials used for each rod?

	W	X	Y
(1)	glass	copper	wood
(2)	steel	glass	copper
(3)	wood	copper	steel
(4)	steel	wood	copper

(Go on to the next page)

- 22 Mary wanted to compare how fast a wooden block can move on different planks using the set-up below. He released the block, measured the distance moved by the block down the plank and the time taken.

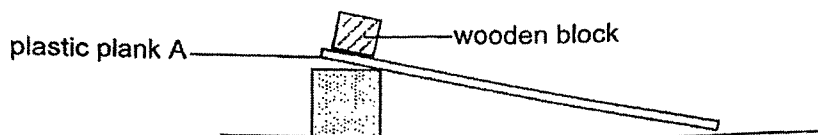

The line graph Y below showed the results for plank A.

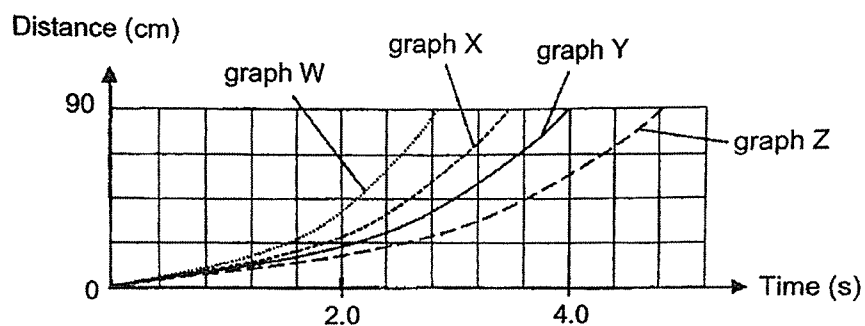

- Mary repeated the experiment with a wooden plank of the same length. She concluded that there is more frictional force between the wooden block and the wooden plank.) Which of the following best describes the result for the wooden plank?

	Graph	Time taken to move a distance of 90 cm
(1)	Graph W	shorter time
(2)	Graph Z	shorter time
(3)	Graph X	longer time
(4)	Graph Z	longer time

(Go on to the next page)

23 A spring is compressed and released at P. It moves to Q as shown. The graph below shows the amount of different types of forces acting on the spring at P.

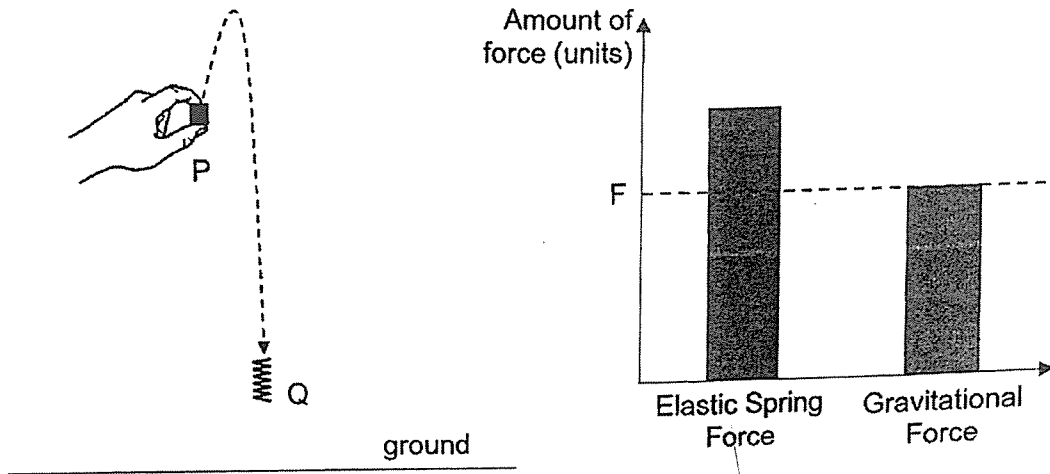

Which of the following graphs shows the amounts of different types of forces acting on the spring at Q before it hits the ground?

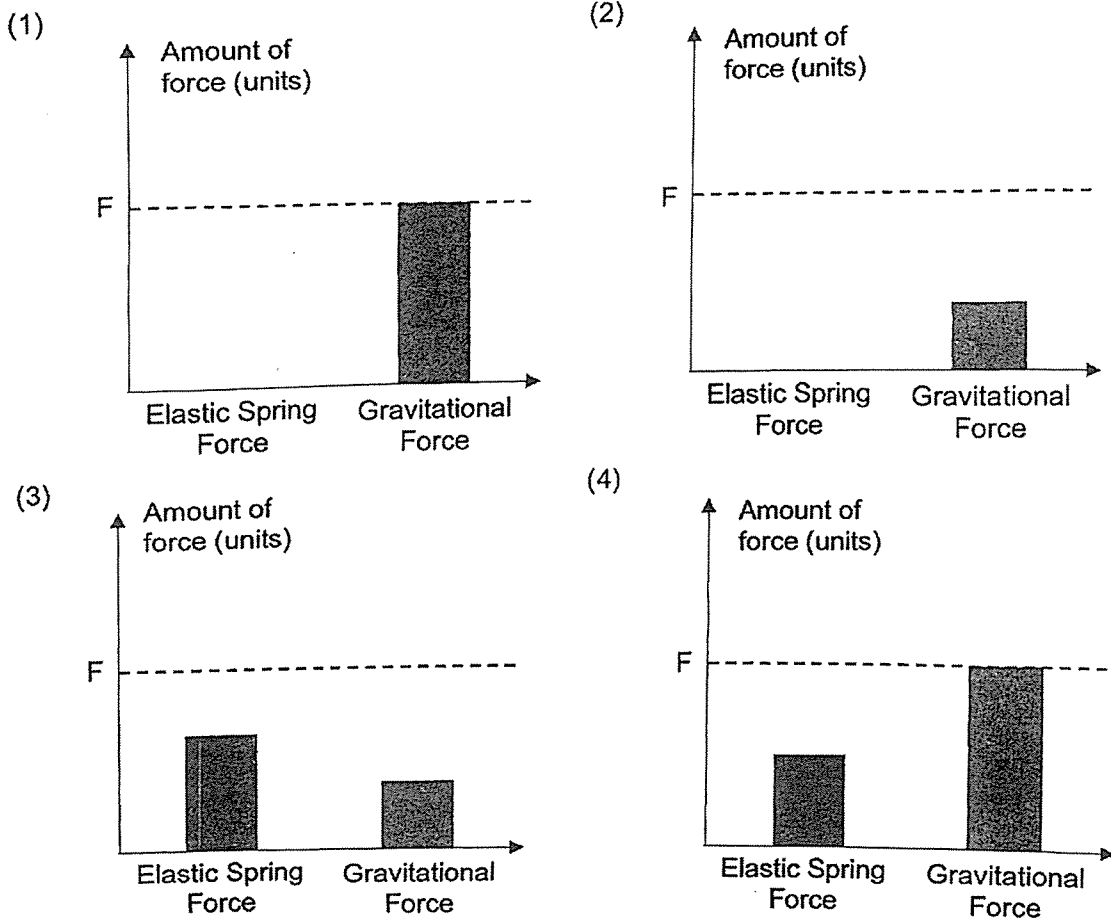

(Go on to the next page)

24 Study the graph below.

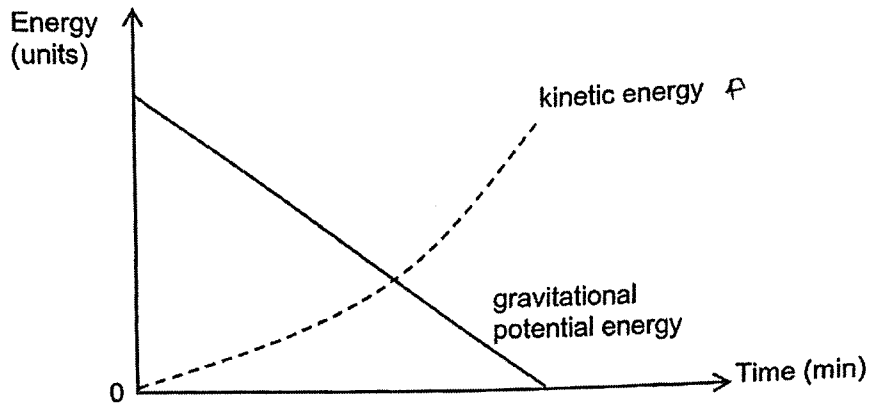

Which of the following involves an energy conversion similar to the graph above?

- (1) A kite flying up in the sky
- (2) A girl jogging around the track
- (3) A pilot taking off in an airplane
- (4) A boy roller-skating down a slope

25

Ravi poured some ice cubes into an empty cup and left them in the kitchen. The room temperature was  $26^{\circ}\text{C}$ .

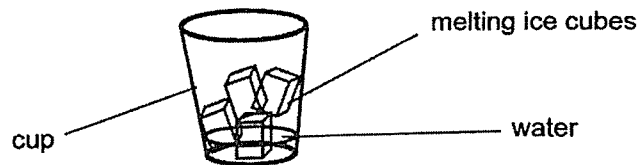

What will happen after some time?

	Temperature of ice cubes	Temperature of water around the ice cubes
(1)	increases	remains at $0^{\circ}\text{C}$
(2)	remains at $0^{\circ}\text{C}$	remains at $0^{\circ}\text{C}$
(3)	remains at $0^{\circ}\text{C}$	increases
(4)	increases	decreases

(Go on to the next page)



26 Study the circuit diagram below.

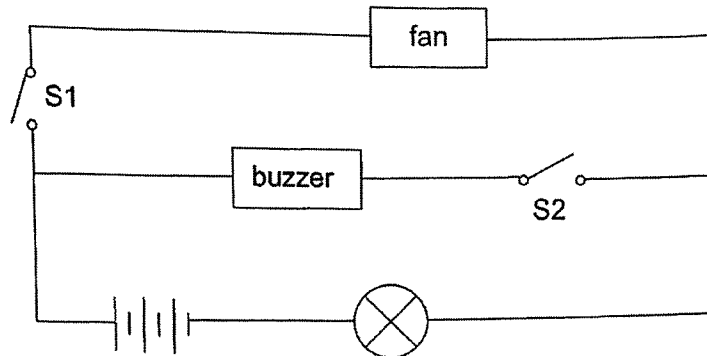

Which one of the following shows the correct energy conversion when S1 is closed and S2 is opened?

- (1) electrical energy  $\rightarrow$  light energy + kinetic energy
- (2) electrical energy  $\rightarrow$  light energy  $\rightarrow$  kinetic energy
- (3) potential energy  $\rightarrow$  electrical energy  $\rightarrow$  light energy + kinetic energy
- (4) potential energy  $\rightarrow$  electrical energy  $\rightarrow$  light energy + sound energy

(Go on to the next page)

27

Nick walked past two streetlamps, X and Y, from position A to E on a dark night as shown in the diagram below.

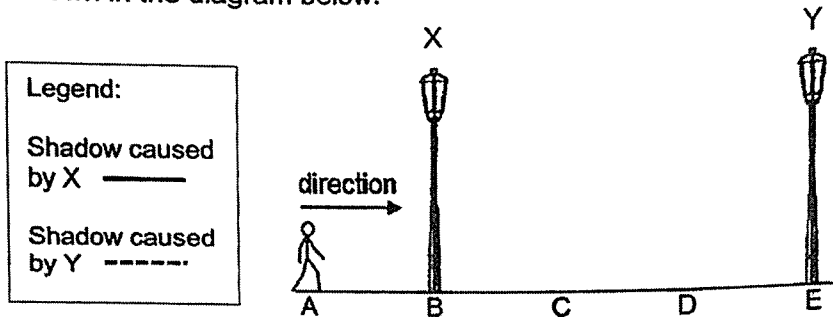

Which of the following graphs shows the length of his shadow as he walks from A to E?

(1)

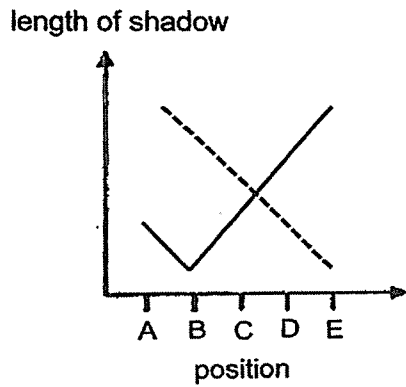

(2)

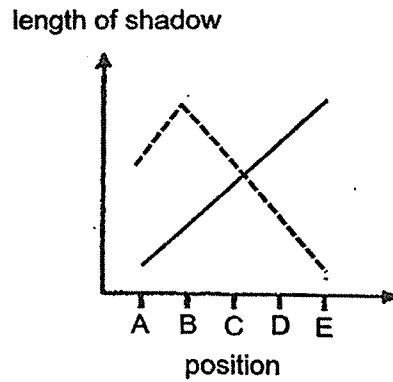

(3)

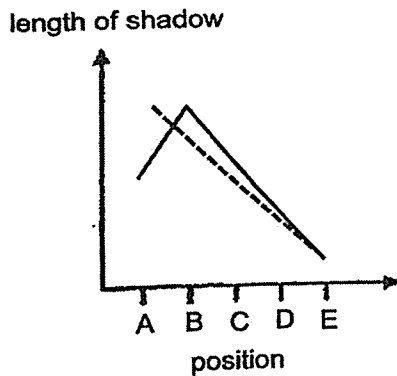

(4)

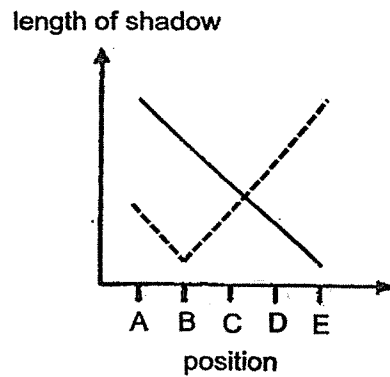

(Go on to the next page)

28

Mr Lee set up a circuit with three identical bulbs, L, M and N. He covered the wires connecting the bulbs with a cardboard leaving only the bulbs visible, as shown in the diagram below.

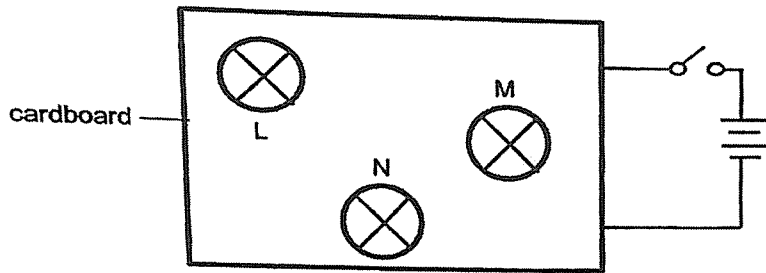

Mr Lee removed the bulbs, L, M and N, one at a time while observing what happened to the other bulbs. He recorded his observations in the table below.

Bulb removed	Observations
L	M went off while N stay lit
M	L went off while N stay lit
N	L and M stay lit

Which one of the following circuits shows how the three bulbs were connected?

(1)

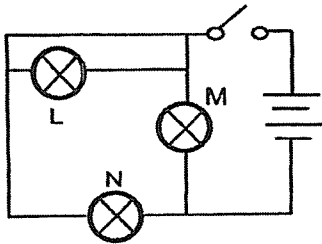

(2)

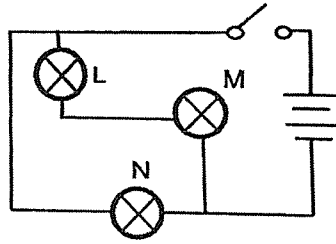

(3)

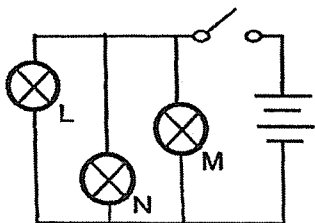

(4)

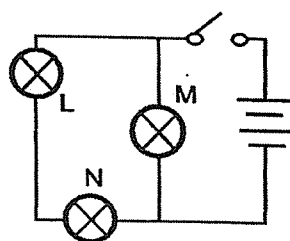

# METHODIST GIRLS' SCHOOL

Founded in 1887



## PRELIMINARY EXAMINATION 2022

PRIMARY 6

SCIENCE

BOOKLET B

Total Time for Booklets A and B: 1 hour 45 minutes

### INSTRUCTIONS TO CANDIDATES

Do not turn over this page until you are told to do so.

Follow all instructions carefully.

Answer all questions.

Name: \_\_\_\_\_ (       )

Class: Primary 6. \_\_\_\_\_

Date : 23 August 2022

Booklet A	56
Booklet B	44
Total	100
Parent's Signature	

This booklet consists of 15 printed pages including this page.

For questions 29 to 40, write your answers in the spaces provided. The number of marks available is shown in brackets [ ] at the end of each question or part question. [44 marks]

29 The diagram below shows two flowers.

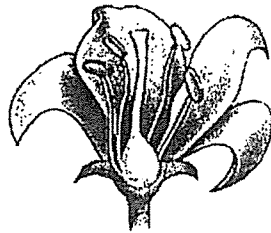

Flower A

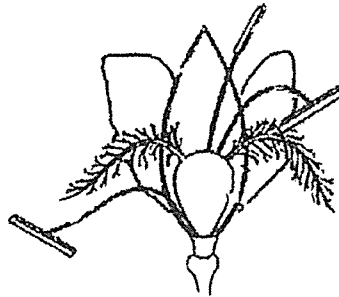

Flower B

(a) Which flower is more likely to be pollinated by wind? Explain your answer based on the reproductive parts of the flower. [1]

---

---

---

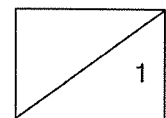

(Go on to the next page)

Study the following flower below.

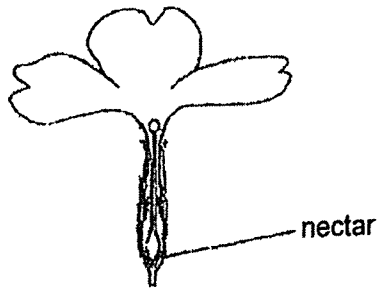

- (b) Which of the following bird, C or D, is more likely to visit the flower? [1]  
Give a reason for your answer.



Bird C



Bird D

---

---

---

- (c) How does the flower benefit the bird? [1]

---

---

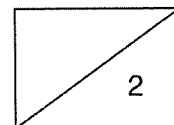

(Go on to the next page)

- 30 Ali conducted an experiment with three identical test tubes A, B and C as shown below.

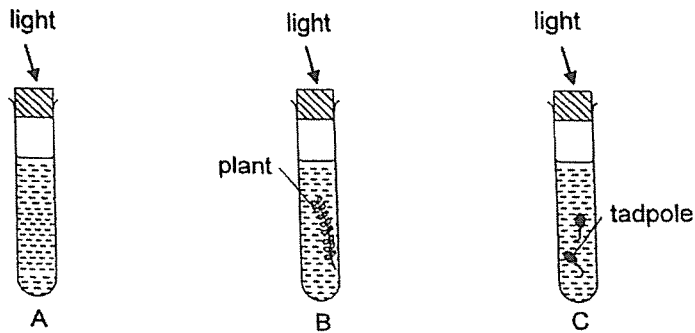

After one day, liquid P was added to the water in the three test tubes. It changes the colour of water according to the amount of carbon dioxide present as shown below.

Increasing amount of carbon dioxide  
 →  
 orange      red      purple

- (a) If the colour of water in test tube A turns red, which test tube will the colour of water more likely turn purple when liquid P is added? Explain your answer. [1]

---



---

- (b) What is the purpose of test tube A? Explain your answer. [1]

---



---

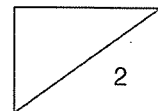

(Go on to the next page)

Ali included another identical test tube D as shown below in the experiment.

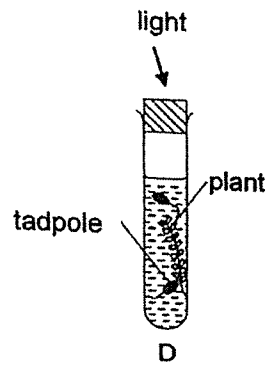

- (c) Ali realized that it is not possible to predict the change in colour of water in test tube D. Explain why. [1]

---

---

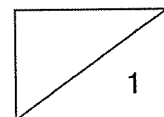

(Go on to the next page)



- 31 Mr Chin planted a potato plant. He removed an outer ring from the stem as shown below so that he could get bigger potatoes. The food-carrying tubes were removed while the water-carrying tubes remained in the stem.

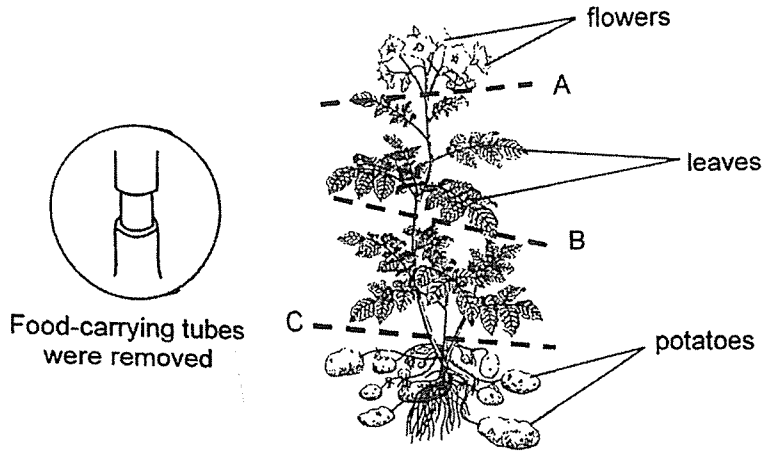

- (a) At which part of the plant, A, B or C, did Mr Chin remove the outer ring from the stem so that bigger potatoes were produced? Explain your answer. [2]

---



---



---

- (b) Name all the substance(s) transported in the stem by the water-carrying tubes. [1]

---



---

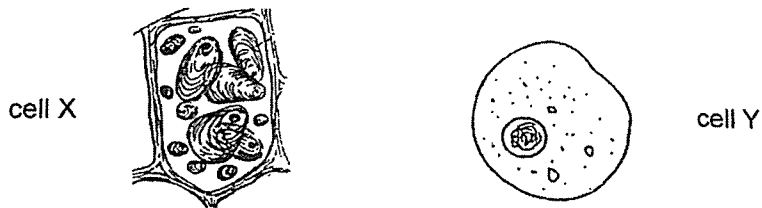

- (c) Which cell, X or Y, is taken from the potato? Give a reason for your answer. [1]

---



---

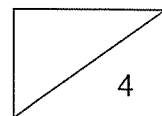

(Go on to the next page)

- 32 Animal A moves very slowly. Its eye stalks allow it to see in any direction and they will retract into the body when they are touched. Besides its eye stalks, its whole body can also retract inside the hard shell.

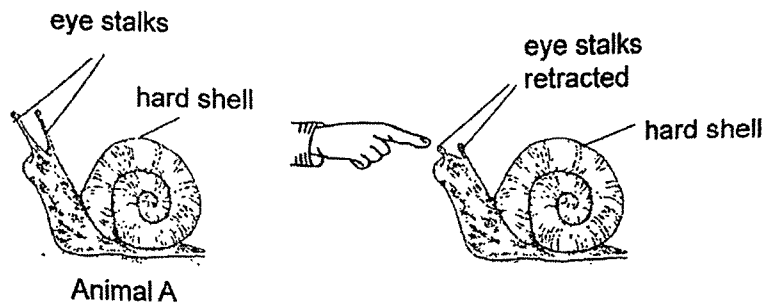

- (a) What characteristic of living things does Animal A display? [1]

---



---

- (b) Based on the above information, explain how Animal A's structural adaptations help it to increase chances of survival. [2]

---



---



---

Animal A lives in a hot and dry environment. The graph below shows the temperature changes inside and outside its shell within a typical day.

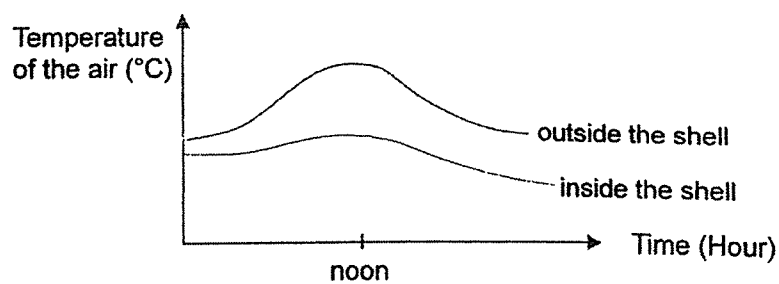

- (c) Based on the graph above, explain how Animal A keeps itself cool. [1]

---



---

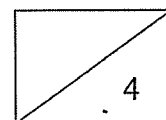

(Go on to the next page)

- 33 Janet wrote down some information about organisms W, S, R and U.

W	S	R	U
Eats S & U	Eats R	Not a prey nor predator	Eats R

- (a) Draw a food web using the above information.

[2]

- (b) Janet wants to investigate whether the presence of water will help dead leaves to decompose faster. She is given the following items for her investigation. She may use some or all of them.

Item	Quantity
Dead leaves	200 g
Garden Soil	200 g
Water	200 g

She uses two identical containers and places them at the same location. State the item(s) and quantity of item(s) in each of the following set-up.

[2]

**Experimental set-up:**

---



---



---

**Control set-up:**

---



---



---

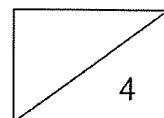

(Go on to the next page)

34 Deforestation by cutting down trees affects the environment.

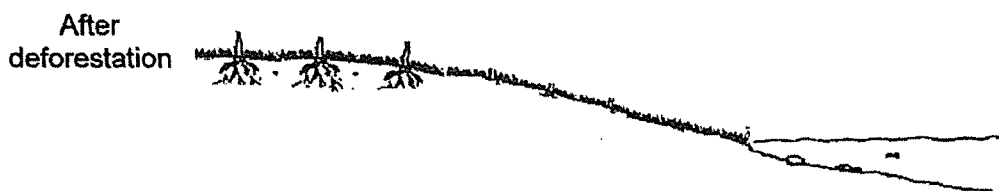
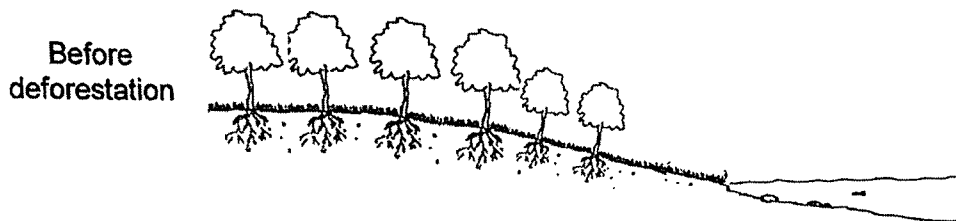

(a) Explain why the water in the river is polluted after deforestation. [1]

---

---

(b) Explain clearly how the polluted river affects the survival of the following groups of organisms - aquatic plants and aquatic animals. [2]

Aquatic plants:

---

---

---

---

Aquatic animals:

---

---

---

---

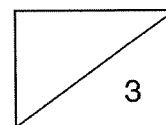

(Go on to the next page)

- 35 Mrs Raj placed a cube made of substance X and Y in the set-up as shown below. Substance X has a melting point of  $52^{\circ}\text{C}$  and substance Y has a higher melting point.

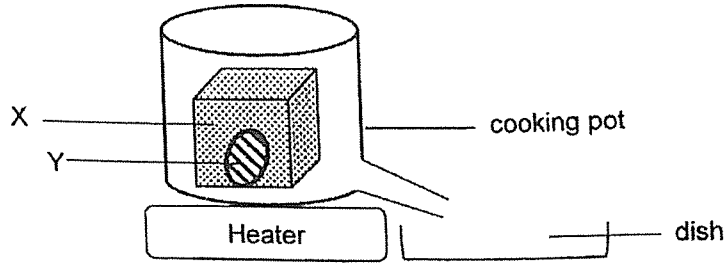

- (a) Mrs Raj wanted to obtain a solid made of substance X only. Explain how she could use the above set-up to do so. [2]

---



---



---

- (b) At what temperature should Mrs Raj set the heater at to ensure that the solid does not contain substance Y? [1]

---



---

- (c) Based on the above information, would you be able to tell the state of substance X at  $120^{\circ}\text{C}$ ? Give a reason for your answer. [1]

---



---

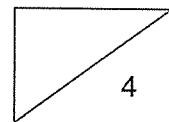

(Go on to the next page)

36

- (a) State a similarity between evaporation and condensation.

[1]

The diagram below shows the temperature inside Yuxuan's house when the air conditioner was switched on. The glass window became fogged and she wrote the word "LOVE" on it.

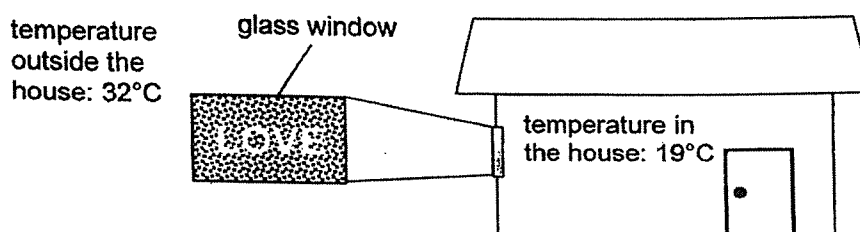

- (b) Explain why the glass window became fogged. Was Yuxuan inside or outside the house when she wrote the word on the glass window? [2]

---



---



---

After a while, the word, 'LOVE', disappeared as shown below.

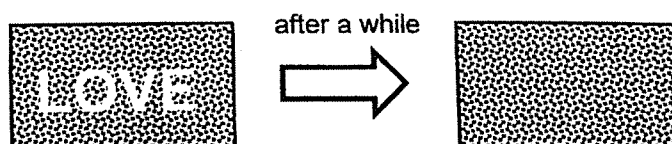

- (c) The word "LOVE" cannot be seen after a while. Explain why.

[1]

---



---



---

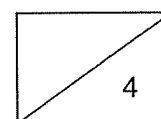

(Go on to the next page)

- 37 The diagram below shows the top view of Beth's toy house and a simplified circuit. There is a light bulb and a switch in each room. All the circuit components are working.

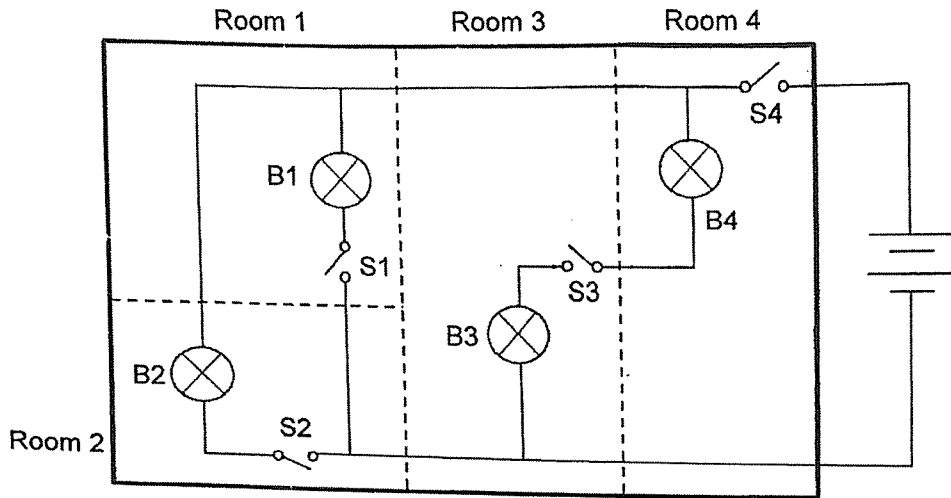

- (a) Based on the diagram above, identify one disadvantage of the circuit. [1]

---



---

Beth redesigned the circuit such that when any two switches are closed, two bulbs will light up with equal brightness. When all switches are closed, all the bulbs light up with equal brightness.

- (b) Draw a circuit below to show how she would connect the 4 bulbs and 4 switches. [3]

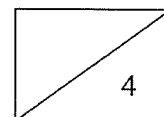
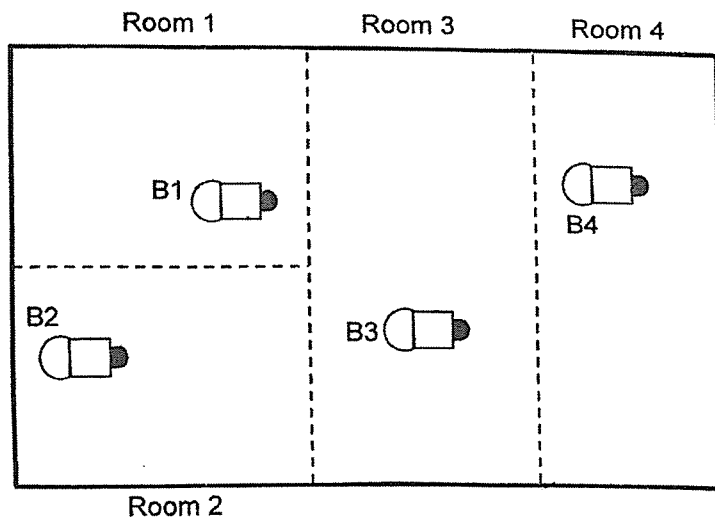

(Go on to the next page)

- 38 Mr Lee placed a container on the ramp as shown in diagram 1. When he let go of his hand, the container slid up the ramp.

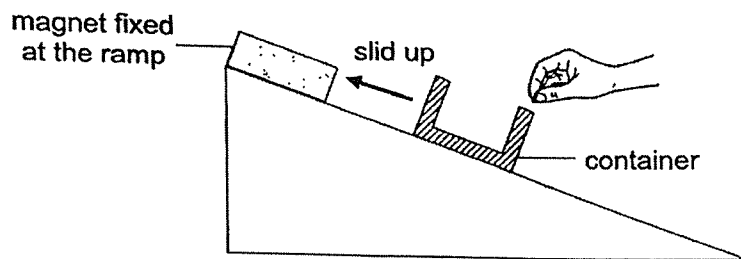

Diagram 1

- (a) State the property of material used to make the container in diagram 1. [1]

---

- (b) State any two forces acting on the container when it was sliding up the ramp. [1]

---

Mr Lee then placed the same container, with a wooden block inside, at the same position on the ramp as shown in diagram 2.

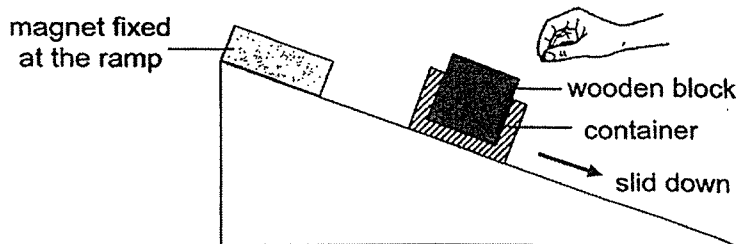

Diagram 2

- (c) Explain, in terms of forces, why the container in diagram 2 slid down the ramp. [1]

---



---

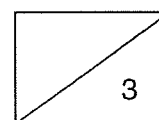

(Go on to the next page)



- 39 John conducted an experiment with a rubber ball using the set-up shown below. He released the ball at point A. The ball only managed to reach point D before falling back towards point C. He repeated the experiment several times and obtained the same results.

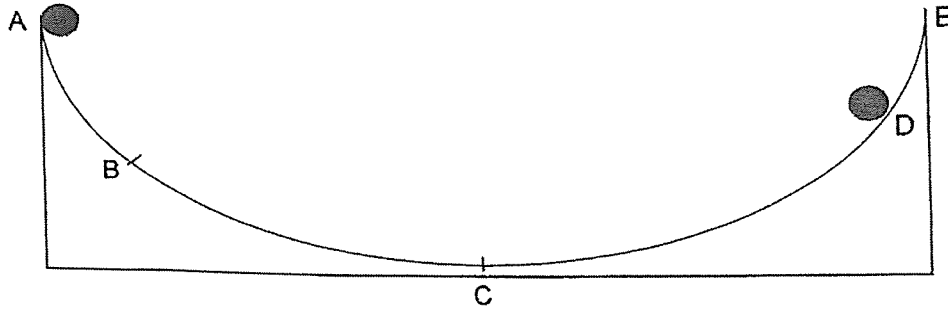

- (a) State the energy conversion as the rubber ball moves from point A to point D. [1]

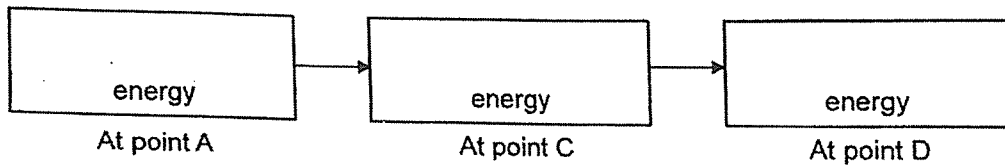

- (b) Explain why the rubber ball cannot reach point E. [2]

---



---



---

- (c) John noticed that the ball moved slower at point B than at point C. Explain his observation in terms of energy conversion.

---



---



---

- (d) Suggest one change to the ramp that will allow the ball to reach a point higher than point D. [1]

---



---



---

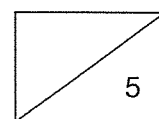

(Go on to the next page)

- 40 Amit wanted to find out which of the two springs, A or B of the same length, is safer to be used for the baby cradle. He hung various weights one at a time and recorded the extension of the two springs in the graph below.

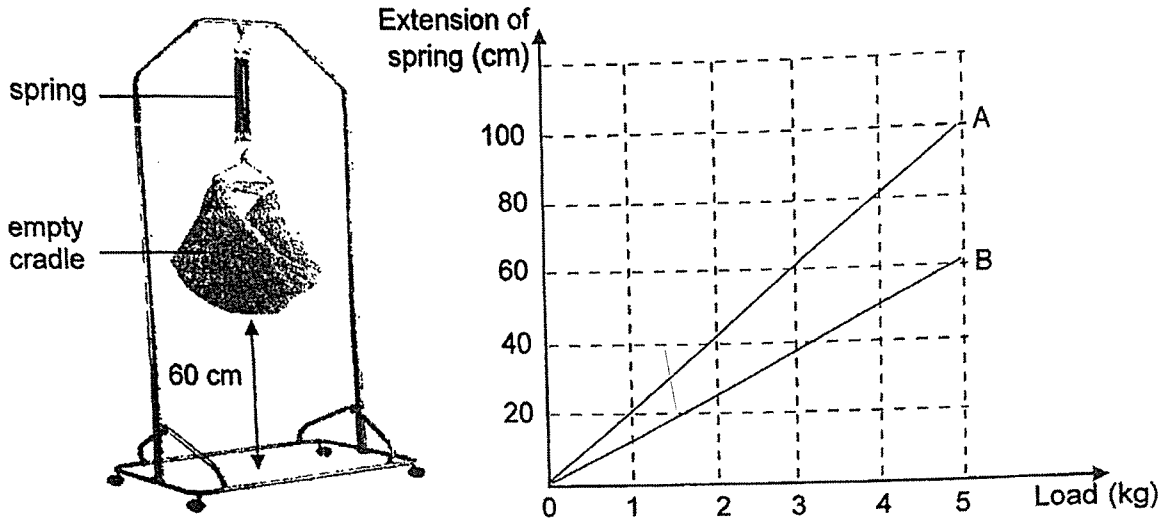

- (a) Based on the above information which spring, A or B, is more suitable to be used for the cradle if Amit's new-born son weighs 3 kg? Explain your answer. [2]

---



---



---

Amit brought his elder son to playground to play on the spring horse. When his son sat on it, the spring horse did not move much.

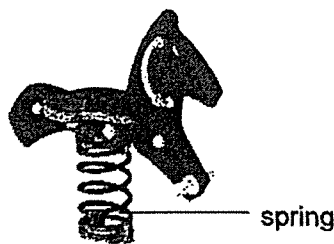

- (b) Suggest a reason for his observation in terms of forces. [1]

---



---



---

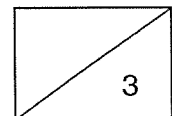

SCHOOL : MGS  
LEVEL : PRIMARY 6  
SUBJECT : SCIENCE  
TERM : PRELIM SA2 2022

---

SECTION A

Q 1	Q2	Q3	Q4	Q5	Q6	Q7	Q8	Q9	Q10
3	2	4	3	1	2	2	2	3	3
Q 11	Q12	Q13	Q14	Q15	Q16	Q17	Q18	Q19	Q20
1	4	2	1	1	2	4	1	2	4
Q21	Q22	Q23	Q24	Q25	Q26	Q27	Q28		
3	4	1	4	2	3	1	2		

**Methodist Girls' School (Primary) P6 Sci  
Prelim 2022 Answer Key**

**Booklet B**

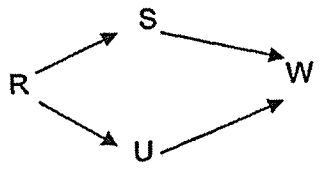
Qn	Answer				
29a	Flower B. The anthers are hanging out of the petal so the pollen grains can be blown away by wind easily. The stigmas are hanging out of the petal so that they can receive the pollen grains easily.				
29b	Bird D. Bird D has a long beak to reach the nectar at the bottom of the flower.				
29c	The flower provides food for the bird.				
30a	Test tube C. The tadpoles give off carbon dioxide (during breathing/ respiration), causing the amount of carbon dioxide in the water to increase.				
30b	Tube A acts a control set-up to confirm that any change in the amount of carbon dioxide in the water is due to the presence of organisms/ living things/ water plants and the tadpoles and not any other variables.				
30c	The amount of carbon dioxide taken in by the plant for photosynthesis and given out by the tadpoles is not known. Therefore, it is not possible to predict of the change of colour in the water.				
31a	Part A. All the leaves are below part A so most amount of food /more food made in the leaves can be transported down and stored in the potatoes, making them bigger.				
31b	Water and mineral salts				
31c	Cell X. Cell X has a cell wall but cell Y does not have a cell wall.				
32a	Living things can respond to changes around them.				
32b	The eye stalks allow animal A to look around and spot its predators from all directions and the hard shell allows animal A to hide in it to protect itself from predators.				
32c	The temperature inside the shell is lower than outside the shell so animal A will hide inside the shell to reduce heat gain from the surrounding to stay cool.				
33a	 <pre> graph LR     R --&gt; S     S --&gt; W     R --&gt; U     U --&gt; W     </pre>				
33b	<table border="1" data-bbox="244 1675 922 1787"> <thead> <tr> <th data-bbox="244 1675 587 1720">Experimental set-up</th> <th data-bbox="587 1675 922 1720">Control set-up</th> </tr> </thead> <tbody> <tr> <td data-bbox="244 1720 587 1787">100g dead leaves &amp; 100g water</td> <td data-bbox="587 1720 922 1787">100g dead leaves</td> </tr> </tbody> </table>	Experimental set-up	Control set-up	100g dead leaves & 100g water	100g dead leaves
Experimental set-up	Control set-up				
100g dead leaves & 100g water	100g dead leaves				
34a	There will be fewer/no roots to hold the (top layer of) soil which will be blown/washed down to the river causing soil erosion.				
34b	As the river becomes more murky, aquatic plants cannot trap light to photosynthesise and die. Without or with fewer plants to produce oxygen during photosynthesis, aquatic animals cannot get enough dissolved oxygen and the population will decrease.				

**Methodist Girls' School (Primary) P6 Sci  
Prelim 2022 Answer Key**

35a	She will heat the cube to the melting point of substance X so that liquid X will flow into the dish. When liquid X in the dish loses heat to the surrounding, it freezes to become solid.
35b	52°C
35c	No because the boiling point of substance X is not known.
36a	Both processes do not occur at fixed temperatures.
36b	Outside the house. The warm water vapour in the surrounding air outside the house came in contact with the cooler surface of the glass window, it lost heat and condensed to form water droplets.
36c	More water vapour condensed (into tiny water droplets) on the cooler glass window, covering the word and causing it to disappear.
37a	S4 (in room 4) must be closed for all the bulbs in other rooms to light up.
37b	<p>The diagram shows a circuit with four rooms: Room 1, Room 2, Room 3, and Room 4. Room 1 contains bulbs B1 and B2. Room 2 contains bulb B2. Room 3 contains bulb B3. Room 4 contains bulb B4. A switch S4 is connected to the main circuit, and its closure causes all other bulbs to light up.</p>
38a	Magnetic material
38b	Gravitational force / magnetic force of attraction / frictional force (between the container and the ramp)
38c	The gravitational force acting on container with the wooden block is greater than the frictional force between the container and the ramp and magnetic force of attraction between magnet and container.
39a	(gravitational) potential energy → kinetic energy → (gravitational) potential energy
39b	Some of the kinetic energy of the ball was converted to heat and sound energy (due to friction between the ball and the ramp). Thus, the ball possessed less kinetic energy to be converted back to (less) gravitational potential energy, so it could not reach point E.
39c	At point B, less of the gravitational potential energy is converted to kinetic energy so the ball possessed less kinetic energy at point B.
39d	Make the surface of the ramp smoother. / Add oil on the ramp.
40a	Spring B is a stiffer spring than spring A. When 3 kg is loaded, spring B extends 40 cm, so the cradle and baby will not hit the floor.
40b	The spring is very stiff and requires a greater load for more compression.

